



[www.herculesstands.com](http://www.herculesstands.com)



# PRODUCT CATALOG



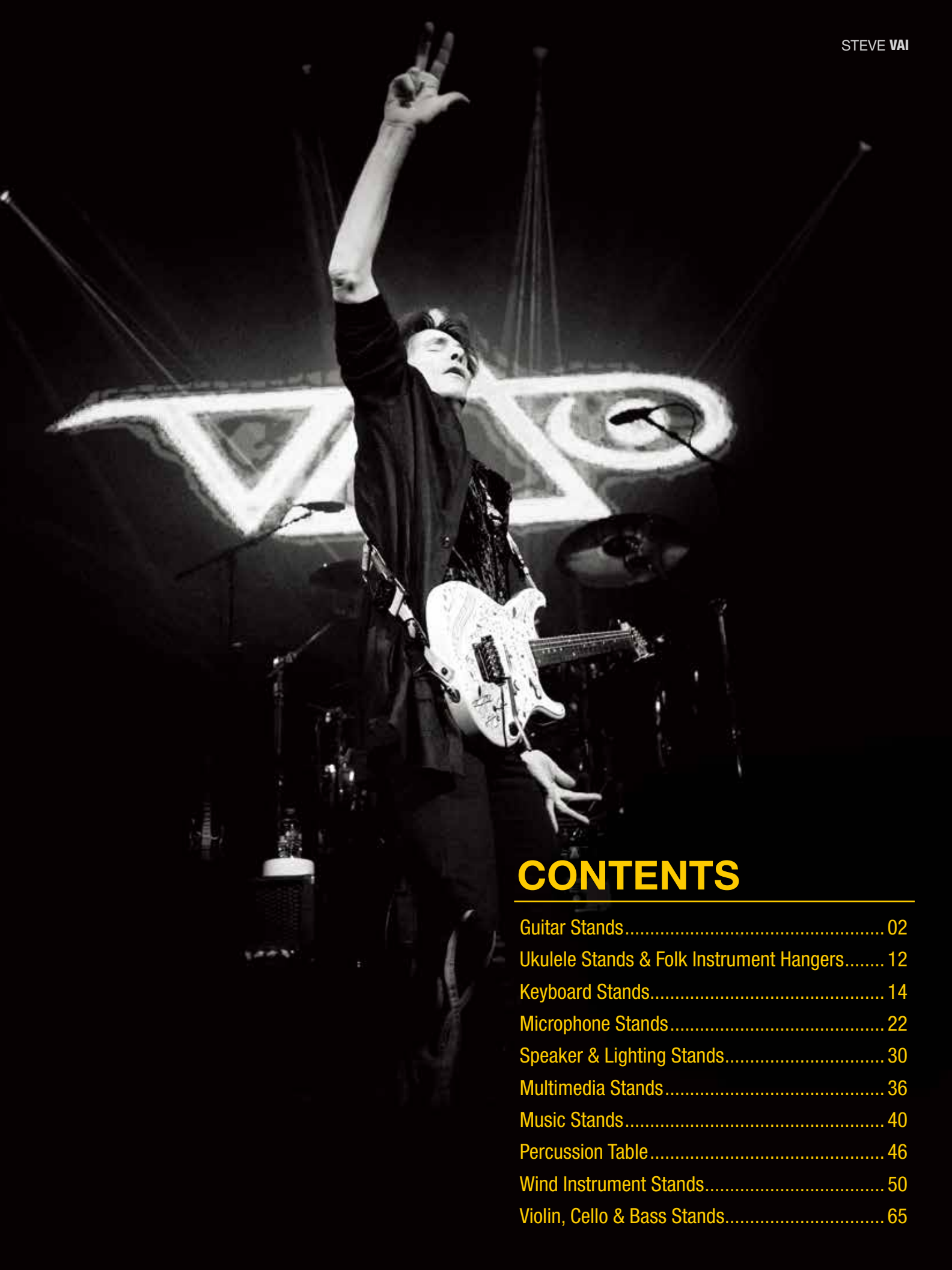

**H**ERCULES STANDS IS COMMITTED TO EFFICIENTLY DEVELOPING ECO-FRIENDLY MATERIALS AND REFINING OUR MANUFACTURING PROCESSES TO FURTHER REDUCE ENERGY CONSUMPTION AND WASTE. OUR PASSIONATE COMMITMENT TO CREATIVE, INNOVATIVE & QUALITY ECO-FRIENDLY PRODUCTS IS STRONGER THAN EVER.

**TRUST**  
SAFE | SECURE | STABLE | STRONG

## CONTENTS

Guitar Stands.....	02
Ukulele Stands & Folk Instrument Hangers.....	12
Keyboard Stands.....	14
Microphone Stands.....	22
Speaker & Lighting Stands.....	30
Multimedia Stands.....	36
Music Stands.....	40
Percussion Table.....	46
Wind Instrument Stands.....	50
Violin, Cello & Bass Stands.....	65

DAVE MUSTAINE  
MEGADETH

## GUITAR STANDS

HERCULES designed the Auto Grip System with the unique locking system to provide the safest most secure stand for you instrument.

Our Auto Grip System (AGS) is engineered to function easily and is built to last. Specially Formulated Foam (SFF) Rubber is widely used on all contact points between stand and your guitar and is safe for most finishes.



Scan this QR Code with your smartphone and watch the Guitar Stands series.

# 1 STAND FOR ACOUSTIC & ELECTRIC GUITARS



Compact Fold Design

### GS200B

#### EZPack Guitar Stand

GS200B features a design that fits both acoustic and electric guitars, hard rubber contact points that protect your instrument and GS200B folds down small enough to fit in your backpack, instrument case or gig bag.

#### Feature

- » The compact size and lightweight design folds and unfolds easily, sets up quickly and goes where you go
- » Design fits both acoustic and electric guitars

#### Specifications

Height: 240 mm (9.5")

Weight: 0.5 kg (1.1 lbs.)

Load Capacity: 10 kg (22 lbs.)

Folded Size: 260 mm × 110 mm × 43 mm  
(10.2" × 4.3" × 1.7")

Base Radius: 400 mm × 280 mm  
(15.7" × 11")



## GS412B PLUS

AGS Guitar Stand w/Backrest

### Features

- » The built-in Auto Grip System safely locks instrument in place
- » Instant Height Adjustment Clutch with locking pin adjusts stand height quickly, easily and securely
- » The Folding Back Rest supports instrument securely, has multi-angle position adjustment and folds up securely for travel
- » Specially Formulated Foam Rubber fully protects instrument at all contact points

### Specifications

Nut Width Range: 40 mm - 52 mm  
(1.57" - 2.05")  
Height: 855 mm - 1,075 mm  
(33.6" - 42.3")  
Weight: 1.7 kg (3.7 lbs)  
Base Radius: 320 mm (12.6")  
Load Capacity: 15 kg (33 lbs)  
Folded Size:  
740 mm x 110 mm x 170 mm  
(29.1" x 4.3" x 6.7")  
Accessories: 1 pair N.I.N.A™ (HA301)



## GS414B PLUS

AGS Guitar Stand

### Features

- » The built-in Auto Grip System safely locks instrument in place
- » Instant Height Adjustment Clutch with locking pin adjusts stand height quickly, easily and securely
- » Specially Formulated Foam Rubber fully protects instrument at all contact points

### Specifications

Nut Width Range: 40 mm - 52 mm  
(1.57" - 2.05")  
Height: 950 mm - 1,150 mm (37.4" - 45.2")  
Weight: 1.88 kg (4.1 lbs)  
Base Radius: 310 mm (12.2")  
Load Capacity: 15 kg (33 lbs)  
Folded Size: 710 mm x 110 mm x 170 mm  
(28" x 4.3" x 6.7")  
Accessories: 1 pair N.I.N.A™ (HA301)



## GS415B PLUS

AGS Guitar Stand w/Foldable Yoke

### Features

- » The folding built-in Auto Grip System safely locks instrument in place
- » Instant Height Adjustment Clutch with locking pin adjusts stand height quickly, easily and securely
- » Specially Formulated Foam Rubber fully protects instrument at all contact points

### Specifications

Nut Width Range: 40 mm - 52 mm  
(1.57" - 2.05")  
Height: 960 mm - 1,150 mm  
(37.8" - 45.3")  
Weight: 2 kg (4.4 lbs)  
Base Radius: 310 mm (12.2")  
Load Capacity: 15 kg (33 lbs)  
Folded Size:  
685 mm x 110 mm x 100 mm  
(27" x 4.3" x 3.9")  
Accessories: 1 pair N.I.N.A™ (HA301)



## GS422B PLUS

AGS 2 Guitar Stand

### Features

- » Two folding built-in Auto Grip System safely locks instrument(s) in place
- » Instant Height Adjustment Clutch with locking pin adjusts stand height quickly, easily and securely
- » The Folding Back Rest supports instrument securely, has multi-angle position adjustment and folds up securely for travel
- » Specially Formulated Foam Rubber fully protects instrument at all contact points

### Specifications

Nut Width Range: 40 mm - 52 mm  
(1.57" - 2.05")  
Height: 925 mm - 1,250 mm (36.4" - 49.2")  
Weight: 2.6 kg (5.7 lbs)  
Base Radius: 430 mm (16.9")  
Load Capacity: 20 kg (44 lbs)  
Folded Size: 780 mm x 130 mm x 115 mm  
(30.7" x 5.1" x 4.5")  
Accessories: 1 pair N.I.N.A™ (HA301)



## GS432B PLUS

AGS 3 Guitar Stand

### Features

- » Three folding built-in Auto Grip system safely locks instrument(s) in place
- » Instant Height Adjustment Clutch with locking pin adjusts stand height quickly, easily and securely
- » The Folding Back Rest supports instrument securely, has multi-angle position adjustment and folds up securely for travel
- » Specially Formulated Foam Rubber fully protects instrument at all contact points

### Specifications

Nut Width Range: 40 mm - 52 mm  
(1.57" - 2.05")  
Height: 925 mm - 1,250 mm (36.4" - 49.2")  
Weight: 2.98 kg (6.6 lbs)  
Base Radius: 430 mm (16.9")  
Load Capacity: 30 kg (66 lbs)  
Folded Size: 780 mm x 150 mm x 150 mm  
(30.7" x 5.9" x 5.9")  
Accessories: 1 pair N.I.N.A™ (HA301)



## GS526B PLUS

AGS 6 Guitar Stand

### Features

- » Six folding built-in Auto Grip System safely locks instrument in place
- » Instant Height Adjustment Clutch with locking pin adjusts stand height quickly, easily and securely
- » The Folding Back Rest supports instrument securely, has multi-angle position adjustment and folds up securely for travel
- » Specially Formulated Foam Rubber fully protects instrument at all contact points

### Specifications

Nut Width Range: 40 mm - 52 mm  
(1.57" - 2.05")  
Height: 1,500 mm - 1,900 mm (59" - 74.8")  
Weight: 5.4 kg (11.9 lbs)  
Base Radius: 530 mm (20.9")  
Load Capacity: 40 kg (88 lbs)  
Folded Size: 1,195 mm x 140 mm x 140 mm  
(47.0" x 5.5" x 5.5")  
Accessories: 2 pair N.I.N.A™ (HA301)



## Auto Grip System

The Auto Grip System PLUS is driven by the weight of Guitar or Bass.



The AGS PLUS has been engineered with a smooth-sliding channel, main body and two arms with SFF rubber.

When the instrument is placed on the yoke, the channel slides down and rotates two arms holding and protecting your guitar. To take the guitar, simply lift the instrument out of the housing, two arms release immediately. Fits guitars with neck from 40 mm – 52 mm (1.57" – 2.05").



Narrow Instrument Neck Adjustment (N.I.N.A™) adapters are specially designed to reduce the distance between the AGS arms.

WATCH THE VIDEO



Foldable Auto Grip System Yoke Supports a wide variety of instruments and folds up securely for travel.



Adjustable Folding Back Rest The multi-angle folding back rest supports a wide variety of instruments and folds up securely for travel.

Our goal at HERCULES is to build the best possible instrument stands. Our stands are intended to give you years of trouble-free use. However, guitar manufacturers use many different finish materials and techniques. Therefore, we advise you read the manufacturers warranty and care guide materials for instructions on the proper care and maintenance of your instrument.

## GS523B

### Multi Guitar Rack - 3

GS523B accommodates three guitars with Specially Formulated Foam (SFF) Rubber on all contact points.

#### Features

- » One-piece design sets up and tears down easily
- » Unique Guitar Yoke designed for acoustic, electric and bass guitars
- » 4 pick slots on each yoke
- » Includes 3 yokes, expands to 6 with HA205

#### Specifications

Height: 640 mm (25.2")  
 Weight: 3.6 kg (7.9 lbs.)  
 Base Radius: 620 mm x 500 mm  
 (24.4" x 19.7")  
 Load capacity: 80 kg (176 lbs.)  
 Folded size: 710 mm x 630 mm x 110 mm  
 (28" x 24.8" x 4.3")



WATCH THE VIDEO



## GS523B PLUS

### Multi Guitar Rack - 3 w/ Casters

GS523B PLUS accommodates three guitars and utilizes Specially Formulated Foam (SFF) padding to cover all contact points.

#### Features

- » One piece design sets up and tears down easily
- » Unique Guitar Yoke design for acoustic, electric and bass guitars
- » Enhanced mobility for easy movement and setup
- » Swappable casters with rubber feet
- » 4 pick slots on each yoke
- » Includes 3 yokes, expands to 6 with HA205

#### Specifications

Height: 715 mm (28.1")  
 Weight: 4.3kg (9.48 lbs.)  
 Base Radius: 670 mm x 550 mm  
 (26.38" - 21.65")  
 Load Capacity: 80 kg (176.37 lbs.)  
 Folded Size: 630 mm x 110 mm x 710 mm  
 (24.80" x 4.33" x 27.95")

CASTERS  
 INSTALLATION VIDEO



## HA205

### Extension Yoke For Rack

HA205 can double the capacity of either the GS523B or the GS525B. Each extension pack includes one yoke and two rings to add one guitar to your GS523B, GS525B, GS523B PLUS, or GS525B PLUS.

#### Features

- » Extension yoke connects easily and securely to GS523B, GS525B, GS523B PLUS, or GS525B PLUS.



GS523B, GS523B PLUS 3+3=6 Guitars  
 GS525B, GS525B PLUS 5+5=10 Guitars

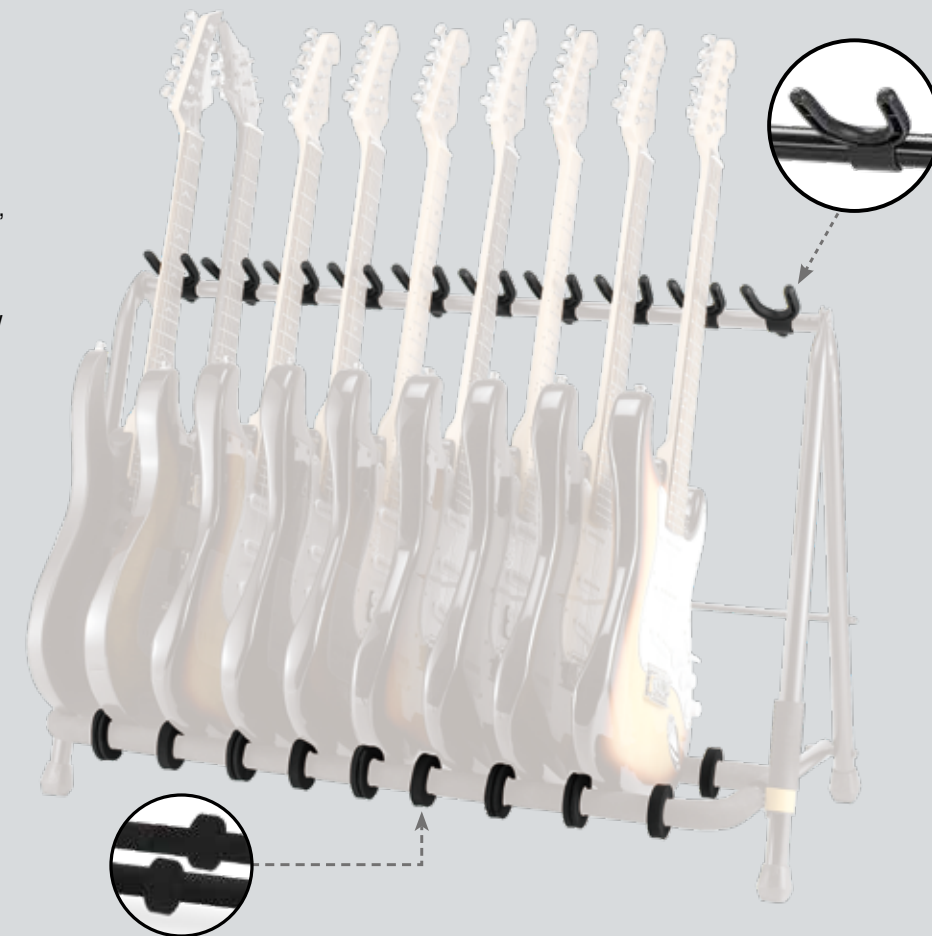

## GS525B

### Multi Guitar Rack - 5

GS525B accommodates five guitars with Specially Formulated Foam (SFF) Rubber on all contact points.

#### Features

- » One-piece design sets up and tears down easily
- » Unique guitar yoke designed for acoustic, electric and bass guitars
- » 4 pick slots on each yoke
- » Includes 5 yokes, expands to 10 with HA205

#### Specifications

Height: 640 mm (25.2")  
 Weight: 4.4 kg (9.7 lbs.)  
 Base Radius: 1,000 mm x 500 mm  
 (39.4" x 19.7")  
 Load capacity: 80 kg (176 lbs.)  
 Folded size: 1,010 mm x 110 mm x 710 mm  
 (39.8" x 4.3" x 28")

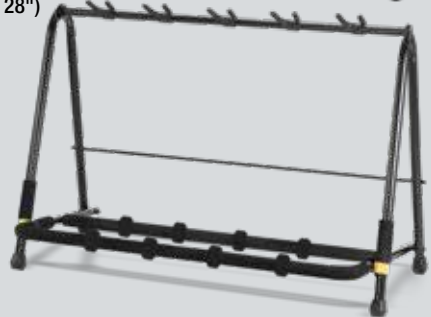

WATCH THE VIDEO



## GS525B PLUS

### Multi Guitar Rack - 5 w/ Casters

GS525B PLUS accommodates five guitars and utilizes Specially Formulated Foam (SFF) padding to cover all contact points.

#### Features

- » One piece design sets up and tears down easily.
- » Unique Guitar Yoke design for acoustic, electric and bass guitars
- » Enhanced mobility for easy movement and setup
- » Swappable casters with rubber feet
- » 4 pick slots on each yoke.
- » Includes 5 yokes, expands to 10 with HA205

#### Specifications

Height: 715 mm (28.1")  
 Weight: 5.1kg (11.24 lbs.)  
 Base Radius: 1,050 mm x 550 mm  
 (41.34" - 21.65")  
 Load Capacity: 80 kg (176.37 lbs.)  
 Folded Size: 1,010 mm x 110 mm x 710 mm  
 (39.76" x 4.33" x 27.95")

CASTERS  
 INSTALLATION VIDEO

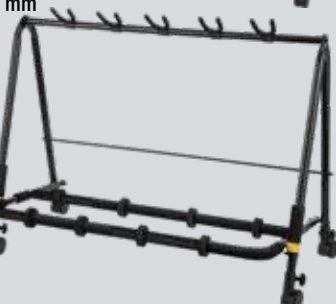

## GS405B

### SHOKSAFE Guitar Stand

GS405B features a shock absorbing system with SHOKSAFE tilting post.

#### Features

- » The SHOKSAFE tilting post and the secure retention system on the upper yoke guard against accidental bumps and collisions
- » The folding bottom yoke locks into position to safely secure instrument in the stand
- » Specially Formulated Foam Rubber fully protects instrument at all contact points

#### Specifications

Height: 735 mm (28.9")  
 Weight: 1.9 kg (4.2 lbs.)  
 Base radius: 270 mm (10.6")  
 Load capacity: 15 kg (33 lbs.)  
 Folded size: 675 mm x 155 mm x 110 mm  
 (25.4" x 6.1" x 4.3")  
 Yoke length: 150 mm (5.9")



## FS100B

### Foot Rest

The Foot Rest has a large foot plate with eco-friendly rubber for non-slip support.

#### Features

- » Height and angle adjusts to 5 positions
- » Large footrest plate
- » Non-slip support, eco-friendly rubber
- » Compact and sturdy

#### Specifications

Height: 130 mm - 265 mm (5.1" - 10.4")  
 Weight: 0.8 kg (1.8 lbs.)  
 Load Capacity: 90 kg (198.4 lbs.)  
 Folded size: 307 mm x 138 mm x 23 mm  
 (12" x 5.4" x 0.9")





### GS401BB

#### Mini Acoustic Guitar Stand

A stable one-piece stand. It is designed to fold up quickly and pack into the included storage bag.

#### Features

- » All-in-one design is easy to pack and carry
- » Locking pins on the base function easily and lock securely
- » Specially Formulated Foam Rubber fully protects instruments at all contact points
- » Storage bag included

#### Specifications

Height: 310 mm (12.2")  
 Weight: 0.96 kg (2.1 lbs.)  
 Base radius: 260 mm (10.2")  
 Load capacity: 15 kg (33 lbs.)  
 Folded size: 282 mm x 105 mm x 100 mm (11.1" x 4.1" x 3.9")  
 Yoke length: 140 mm (5.5")

The storage bag is constructed from environmentally friendly materials. The non-woven fabrics used are recyclable, helping to conserve natural resources.



Compact Fold Design

### GS402BB

#### Mini Electric/Bass Guitar Stand

A stable one-piece stand. It is designed to fold up quickly and pack into the included storage bag.

#### Features

- » All-in-one design is easy to pack and carry
- » Locking Pins on the base function easily and lock securely
- » Specially Formulated Foam Rubber fully protects instruments at all contact points
- » Storage bag included

#### Specifications

Height: 310 mm (12.2")  
 Weight: 0.9 kg (1.9 lbs.)  
 Base radius: 230 mm (9")  
 Load capacity: 15 kg (33 lbs.)  
 Folded size: 282 mm x 105 mm x 100 mm (11.1" x 4.1" x 3.9")  
 Yoke length: 65 mm (2.6")

### GSB001

#### Carrying Bag

Carry bag for HERCULES Guitar Stands:  
 GS412B PLUS / GS414B PLUS / GS415B PLUS / GS422B PLUS / GS432B PLUS / GS405B  
 – Also fits: DS730B / DS520B / DS561B / DS580B

#### Features

- » Heavy-duty nylon
- » Drawstring opening
- » Shoulder strap

#### Specifications

Size: 800 mm x 110 mm (31.5" x 4.3")  
 Load Capacity: 9 kg (20 lbs.)



## TRAVLITE SERIES

The HERCULES TravLite Series is designed for touring musicians that demand light, portable, solid stands.



The TravLite guitar stands feature sturdy steel construction and are fully collapsible. These stands fit easily into most gig bags or back packs.

#### Features

- » Compact slim design folds flat for easy transport
- » Specially Formulated Foam Rubber fully protects instruments at all contact points
- » Non-slip Specially Formulated Rubber Pads adjust to safely accommodate instruments (GS303B Model Only)

### GS301B

#### TRAVLITE Acoustic Guitar Stand

The sturdy yet light-weight steel construction fits acoustic guitars and most vihuelas.

#### Specifications

Height: 250 mm (9.8")  
 Weight: 0.9 kg (1.9 lbs.)  
 Base radius: 325 mm x 255 mm (12.8" x 10")  
 Load capacity: 15 kg (33 lbs.)  
 Folded size: 300 mm x 245 mm x 50 mm (11.8" x 9.6" x 1.9")  
 Yoke depth: 146 mm (5.7")

### GS302B

#### TRAVLITE Electric Guitar Stand

The sturdy yet light-weight steel construction fits electric/bass guitars.

#### Specifications

Height: 250 mm (9.8")  
 Weight: 0.9 kg (1.9 lbs.)  
 Base radius: 325 mm x 255 mm (12.8" x 10")  
 Load capacity: 15 kg (33 lbs.)  
 Folded size: 300 mm x 245 mm x 50 mm (11.8" x 9.6" x 1.9")  
 Yoke depth: 68 mm (2.6")

### GS303B

#### TRAVLITE Folk Instrument Stand

Solid, sturdy and compact. For banjos, mandolins, ukuleles and violins.

#### Specifications

Height: 250 mm (9.8")  
 Weight: 0.9 kg (1.9 lbs.)  
 Base radius: 280 mm x 255 mm (11" x 10")  
 Load capacity: 15 kg (33 lbs.)  
 Folded size: 260 mm x 245 mm x 100 mm (10.2" x 9.6" x 3.9")  
 Yoke depth: 90 mm (3.5")

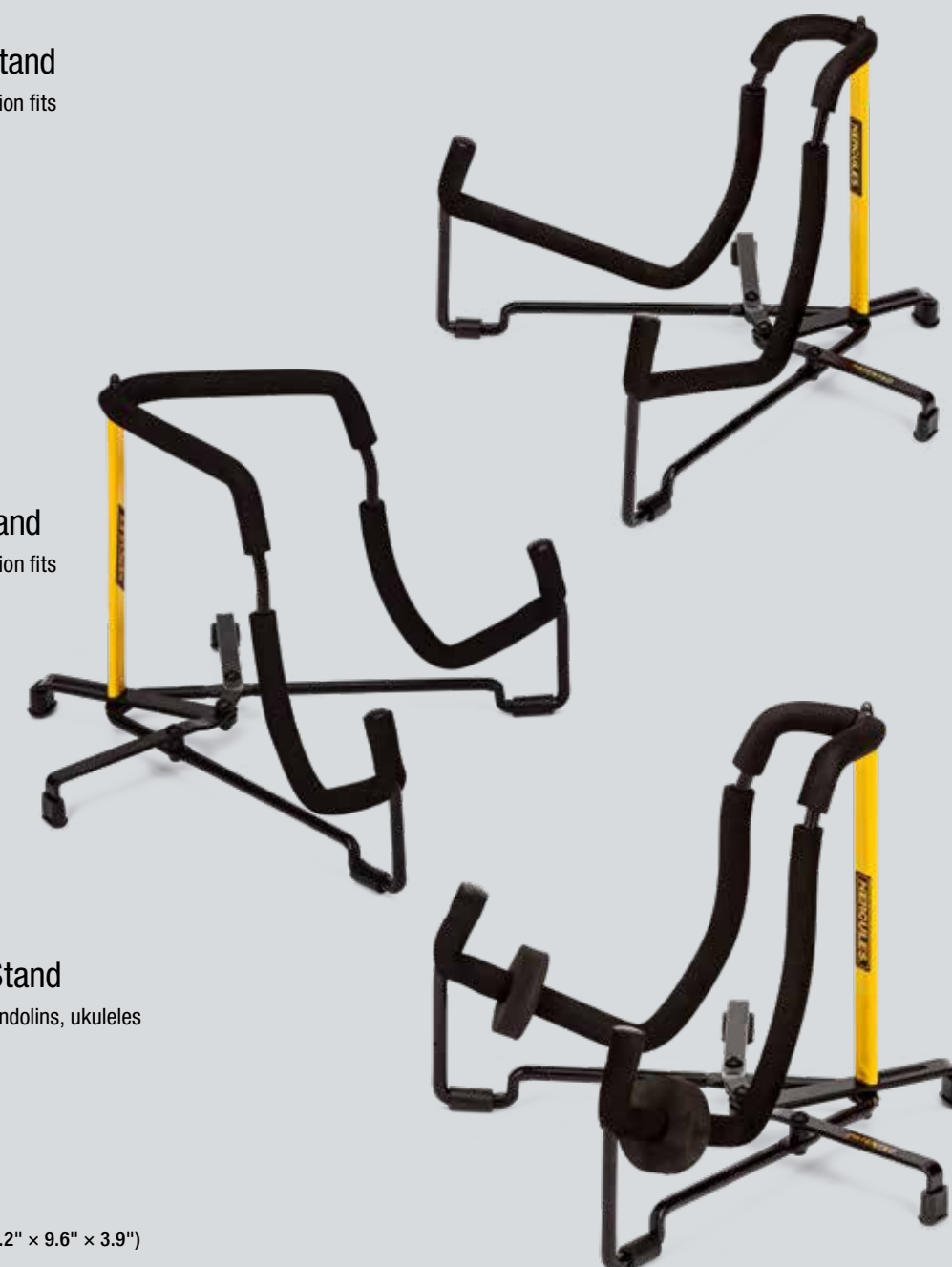

## HA206

### Guitar Neck Cradle

HA206 holds the instrument neck safely, keeping it stable during the tech process. Height adjustable, accommodates most stringed instruments.

#### Features

- » Stable, safe, secure positioning
- » Specially Formulated Foam Rubber protects instrument

#### Specifications

Height: 110 mm – 120 mm (4.3" – 4.7")  
 Weight: 0.2 kg (0.5 lbs.)  
 Load Capacity: 15 kg (33 lbs.)  
 Folded size: 120 mm x 155 mm x 35 mm (4.7" x 6.1" x 1.4")



## HA101S

### AGS Guitar Stand/Hanger System Lock

#### Features

- » Locks instruments in AGS stands
- » 1 lock + 2 keys per package
- » 24 packages per counter display box

## HA201

### Dealer Pack, Lock For AGS Guitar Stands

#### Features

- » 12 locks + 3 keys in a package
- » Protects and secures instrument in stand
- » Prevents unwanted handling of instruments
- » Deters theft



## HA301

### Narrow Instrument Neck Adjustment (NINA™)

#### Features

- » Increases the thickness of AGS arms.
- » Accommodates narrow neck instruments (like banjos and mandolins) and different neck sizes from min. 28 mm (1.1")
- » Suitable for plus series guitar stands & hangers (e.g. GS414B PLUS)



## Auto Grip System (AGS) Guitar Hangers

Supports symmetric and asymmetric guitar necks that allows for multi-angle adjustments while safely locking instrument in place.

Arm Length from base: 105 mm (4.1"), Load capacity: 7 kg (15.4 lbs.)

### GSP38WB PLUS Wall mount with screws



Accessories: 1 pair N.I.N.A™ (HA301)

### GSP38WBK PLUS Wall mount with screws

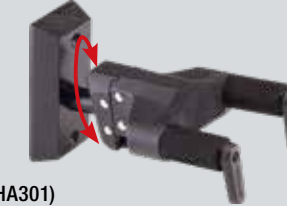

Accessories: 1 pair N.I.N.A™ (HA301)

### GSP38WBR PLUS Wall mount with screws



Accessories: 1 pair N.I.N.A™ (HA301) Exclusive offer within certain regions

### GSP38WBW PLUS Wall mount with screws



Accessories: 1 pair N.I.N.A™ (HA301) Exclusive offer within certain regions

### GSP39WB PLUS Wall mount with screws



Accessories: 1 pair N.I.N.A™ (HA301)

### GSP39SB PLUS Fits slatwall

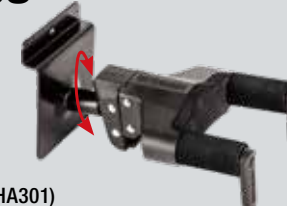

Accessories: 1 pair N.I.N.A™ (HA301)

## AutoSwivel and Adjustable Yoke Hangers

The hangers feature both autoswivel and adjustable yoke which pivots left and right so you can display your guitar or bass facing different directions.

Arm length from base: 275 mm (10.8"), load capacity: 7 kg (15.4 lbs.)

### GSP40SB PLUS Fits slatwall

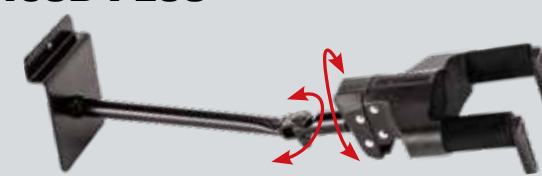

Accessories: 1 pair N.I.N.A™ (HA301)

### GSP40WB PLUS Wall mount with screws



Accessories: 1 pair N.I.N.A™ (HA301)

### GSP40B PLUS Fits pegboard

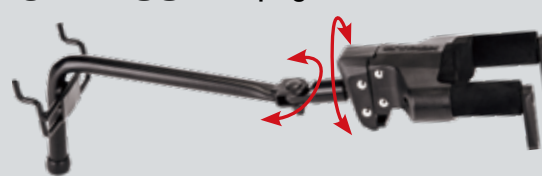

Accessories: 1 pair N.I.N.A™ (HA301)

### GSP40HB PLUS Fits gridwall

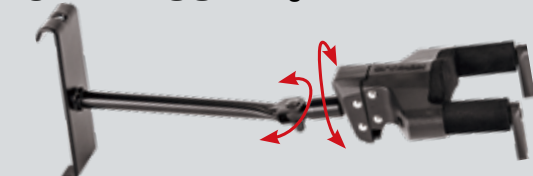

Accessories: 1 pair N.I.N.A™ (HA301)

### GSP50HB PLUS Fits gridwall

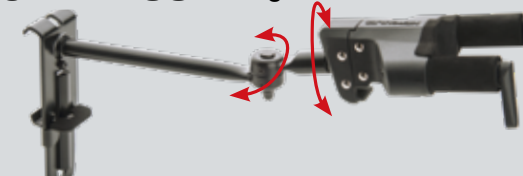

Accessories: 1 pair N.I.N.A™ (HA301)

### GSP50SB PLUS Fits slatwall

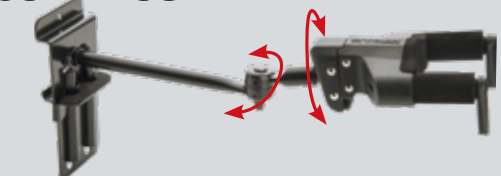

Accessories: 1 pair N.I.N.A™ (HA301)

## UKULELE STANDS & FOLK INSTRUMENT HANGERS

For decades, Hercules Stands has been offering the most advanced protection for countless guitars around the world. With our innovative Auto Grip System, the instruments are safely locked-in and well supported. Now, this technology has been incorporated into the new ukulele and folks instrument stands to ensure your priceless instruments are held and protected like no other.

WATCH DEMO VIDEO



### UKS100B

#### AGS Single Ukulele Stand

The Ukulele Stand UKS100B features the foldable Auto Grip System (AGS) yoke, Instant Height Adjustment Clutch and Specially Formulated Foam (SFF) rubber on all contact points.

#### Features:



Foldable Auto Grip System safely locks ukulele in place



Instant height adjustment clutch with locking pin adjusts stand height quickly, easily and securely

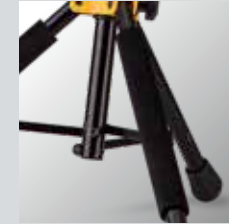

Specially Formulated Foam (SFF) rubber fully protects your instrument on all contact points



The stand folds up compactly for easy transport and storage

#### Specifications:

Height: 575 mm-815 mm (22.6"-32.1")  
 Weight: 0.8 kg (1.8 lbs.)  
 Base Radius: 210 mm (8.3")  
 Load Capacity: 4 kg (8.8 lbs.)  
 Folded Size: 475 mm x 90 mm x 80 mm (18.7" x 3.5" x 3.1")



### USP20CB

#### AGS Ukulele Clamp

The Ukulele Clamp USP20CB features the Auto Grip System (AGS) yoke and a fully adjustable clamp that can be attached to a round or square tube and desks.

#### Specifications

Weight: 0.4 kg (0.9 lbs.)  
 Load Capacity: 4 kg (8.8 lbs.)  
 Folded Size: 90 mm x 75 mm x 230 mm  
 (3.54" x 2.95" x 9.06")  
 Clamping Range:  
 15 mm - 33 mm (0.6" - 1.3")



### USP10WB

#### Folk Instrument Hanger Wall mount with screws

The Ukulele Hanger USP10WB features the Auto Grip System (AGS) yoke and an attractive wood base for home or studio use.

#### Specifications

Arm Length: 100 mm (3.9")  
 Load Capacity: 4 kg (8.8 lbs.)



### USP10SB

#### Folk Instrument Hanger Fits slatwall

The Ukulele Hanger USP10SB features the Auto Grip System (AGS) yoke and a slatwall base for display use.

#### Specifications

Arm Length: 100 mm (3.9")  
 Load Capacity: 4 kg (8.8 lbs.)





## KEYBOARD STANDS

HERCULES sets the standard for quality and durability with its full line of keyboard stands.

EZ-LOK and AutoLock keyboard stands are designed for easy setup, height adjustment and tear down.

Choose HERCULES keyboard stands. Always Strong, always Safe, always Stable, always Secure.



# TRAVLITE SERIES



## KS118B

### Travlite Single X-Keyboard Stand

Compact, one-piece design that travels well.

#### Features

- » Trigger height adjustment with six settings
- » Quick and easy set up and tear down
- » Adjustable rubber foot provides stability

#### Specifications

Weight: 3.4 kg (7.5 lbs.)  
 Load Capacity: 80 kg (176 lbs.)  
 Folded Size: 990 mm x 150 mm x 90 mm  
 (39.0" x 5.9" x 3.5")



Trigger Adjuster

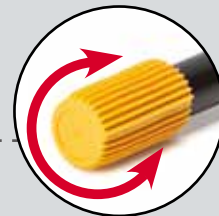

An Adjustable Rubber Foot is fitted and provides stability on uneven floors.

## KEYBOARD STAND HEIGHT & WIDTH POSITIONS

Position	Height	KS100B Width	KS118B Width
A	540 mm (21.3")	875 mm (34.4")	850 mm (33.5")
B	660 mm (26")	790 mm (31.1")	770 mm (30.3")
C	770 mm (30.3")	685 mm (26.9")	665 mm (26.2")
D	860 mm (33.9")	565 mm (22.2")	550 mm (21.7")
E	930 mm (36.6")	430 mm (16.9")	420 mm (16.5")
F	980 mm (38.6")	290 mm (11.4")	285 mm (11.2")

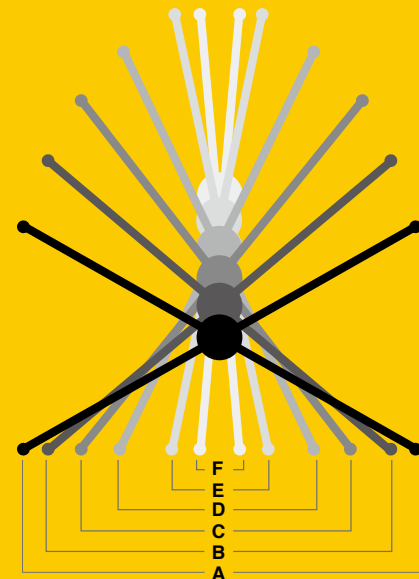

## KS001

### Travlite Keyboard Stand Carry Bag for KS118B

#### Specifications

Size: 1,030 mm x 125 mm x 100 mm (40.5" x 4.9" x 3.9")  
 Load Capacity: 10 kg (22 lbs.)



## KS100B

### EZSTEP Single X-Keyboard Stand

#### Features

- » EZStep foot pedal for 6 easy and quick height settings
- » Collapsible and foldable design, storage size much smaller than standard keyboard stands.

#### Specifications

Weight: 3.35 kg (7.2 lbs.)  
 Load Capacity: 80 kg (176 lbs.)  
 Folded Size: 990 mm x 78 mm x 90 mm (39" x 3.5" x 3.1")

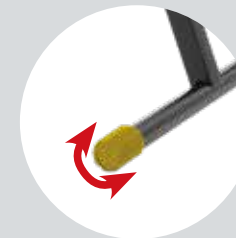
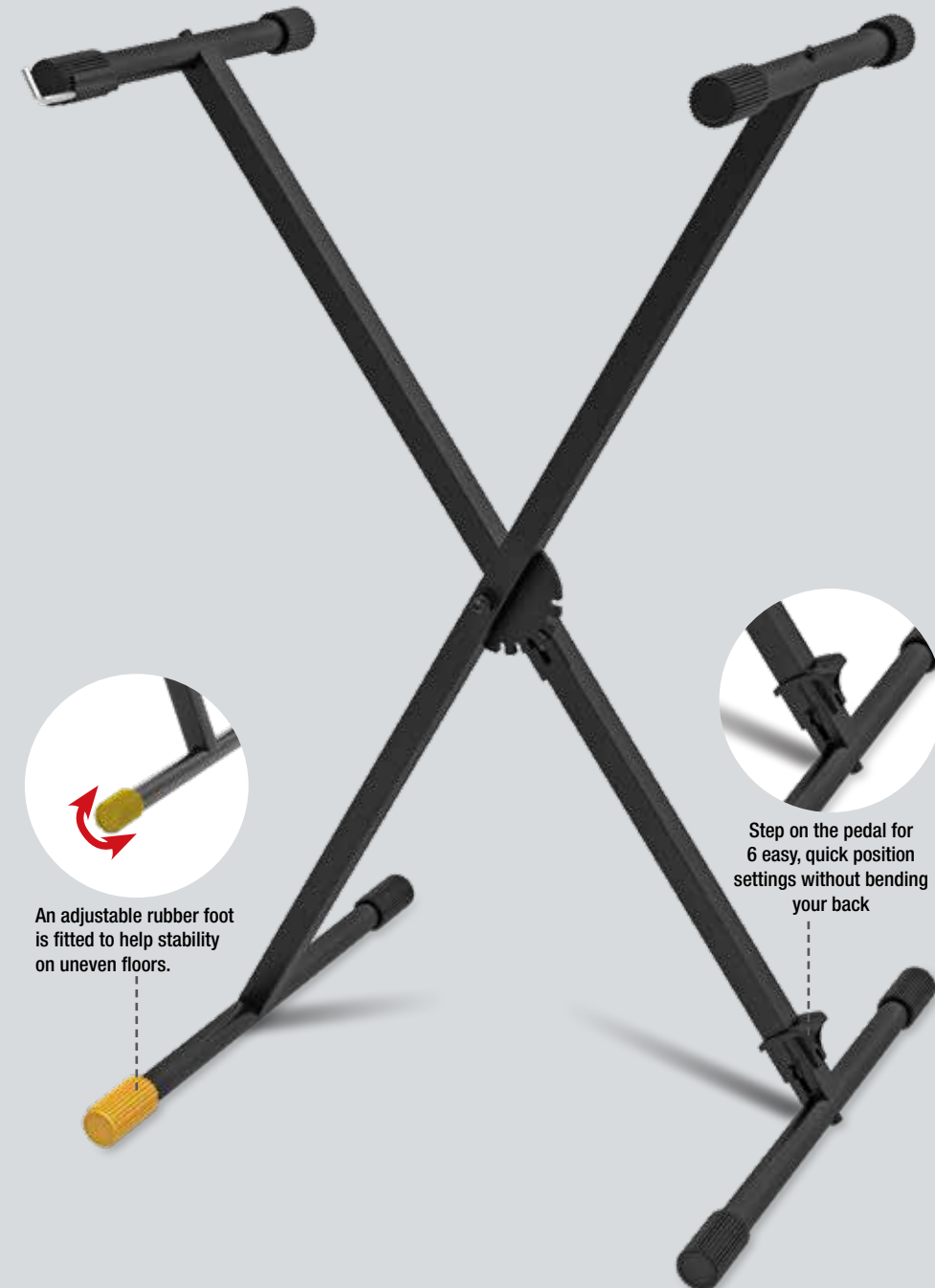

An adjustable rubber foot is fitted to help stability on uneven floors.



Step on the pedal for 6 easy, quick position settings without bending your back

**KS110B**

**EZ-LOK Single X-Keyboard Stand**

**Features**

- » EZ-LOK System with 5-height settings automatically locks the stand in place
- » Heavy-duty round and square steel tubes and a durable finish
- » Adjustable rubber foot provides stability

**Specifications**

Weight: 3.2 kg (7 lbs.)  
 Load capacity: 80 kg (176 lbs.)  
 Folded size: 1,033 mm x 515 mm x 110 mm (40.7" x 20.3" x 4.3")

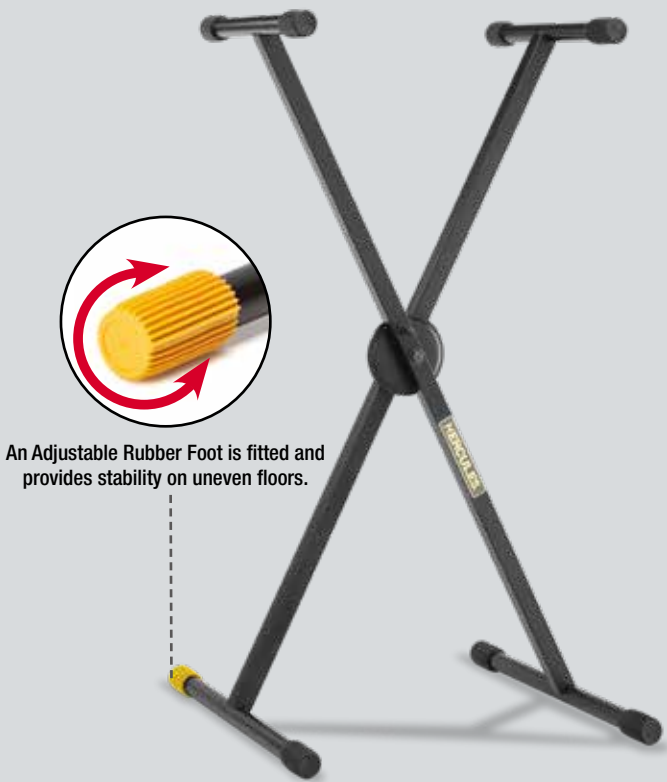

An Adjustable Rubber Foot is fitted and provides stability on uneven floors.

**KS120B**

**EZ-LOK Double X-Keyboard Stand**

The Double X-Style Keyboard Stand features our EZ-LOK, 5-height settings, heavy-duty round and square steel tubes and a durable finish. Double braces provide greater strength and stability.

**Specifications**

Weight: 5.9 kg (13 lbs.)  
 Load Capacity: 100 kg (220 lbs.)  
 Folded size: 1,033 mm x 515 mm x 110 mm (40.7" x 20.3" x 4.3")



An Adjustable Rubber Foot is fitted and provides stability on uneven floors.

**KS210B**

**EZ-LOK Double Tier X-Keyboard Stand**

**Features**

- » EZ-LOK System with 4-height settings
- » Heavy-duty round and square steel tubes with a durable finish
- » Adjustable rubber foot provides stability

**Specifications**

Weight: 8.4 kg (18.5 lbs.)  
 Upper tier depth: 340 mm (13.4"); Load capacity: 40 kg (88 lbs.)  
 Lower tier depth: 400 mm (15.7"); Load capacity: 80 kg (176 lbs.)  
 Folded size: 1,115 mm x 505 mm x 115 mm (43.8" x 19.9" x 4.5")



Adjustable Stopper accommodates a variety of keyboard sizes

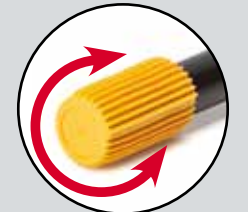

An adjustable rubber foot is fitted and provides stability on uneven floors.

EASY ASSEMBLY VIDEO



**KS110B & KS120B - HEIGHT AND WIDTH SPECIFICATIONS**

Position	Height	Width
A	520 mm (20.3")	860 mm (33.5")
B	675 mm (26.3")	750 mm (29.3")
C	805 mm (31.4")	620 mm (24.2")
D	905 mm (35.3")	470 mm (18.3")
E	980 mm (38.6")	290 mm (11.3")

KS110B & KS120B - Height and Width Specifications.

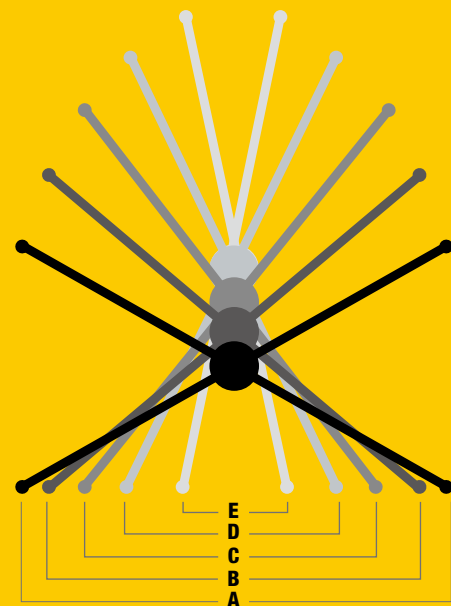

**EZ-LOK**

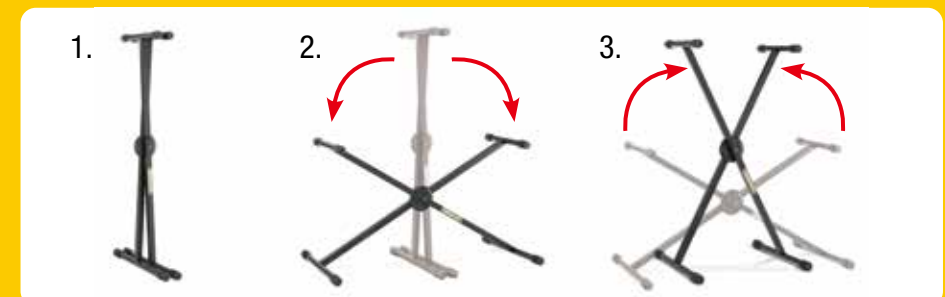

Simply set the stand by: 1st, closing the stand entirely, 2nd opening it all the way to the lowest level and 3rd raising it to the desired height. The EZ-LOK System automatically locks stand into one of five height settings. No more fussing with screws! Repeat above operation 1-3 to reset the height.

## KS400B

### Autolock Z-Keyboard Stand

#### Features

- » AutoLock System with AutoLock Lever adjusts height setting easily and is safe and secure
- » Locking Pins and adjustable moving arms for easy set up and tear down
- » The Adjustable Rubber Foot fine tunes height and levels the KS400B for maximum stability

#### Specifications

Height: 605 mm - 930 mm (23.8" - 36.6")

Width: 510 mm - 850 mm (20" - 33.5")

Weight: 7.5 kg (16.5 lbs.)

Load capacity: 130 kg (287 lbs.)

Folded size: 705 mm x 605 mm x 175 mm (27.7" x 23.8" x 6.9")

Support depth: 450 mm (17.7")

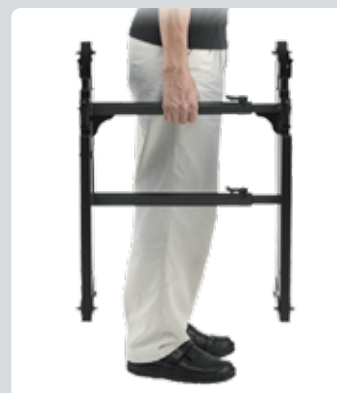

One-piece design folds up compactly.



Adjustable rubber foot for height fine tuning and stable leveling.



## KB200B

### EZ Height Adjust Keyboard Bench

#### Features

- » EZ Height Adjustment lever with 4 height settings
- » Micro Adjuster fine tunes height setting
- » The Adjustable Rubber Foot provides stability on uneven floors

#### Specifications

Seat size: 600 mm x 320 mm (23.6" x 12.6")

Height settings: 480 mm, 510 mm, 530 mm, 560 mm  
(18.9", 20.1", 20.9", 22")

Weight: 6.5 kg (14.3 lbs.)

Load capacity: 150 kg (331 lbs.)

Folded size: 747 mm x 380 mm x 170 mm  
(29.4" x 15" x 6.7")

#### Micro Adjuster

The HERCULES Micro Adjuster lets you fine tune the height for more comfortable sitting. Turn the knob for up to 8 cm (3.14") of additional adjustment.

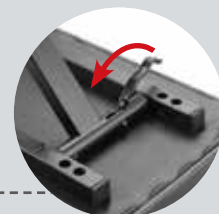

#### EZ Height Adjustment

The built-in spring system allows you to quickly jump from one height setting to the next. Just pull the lever to switch between 4 preset seat heights.

## KS410B

### Autolock Z-Keyboard Stand w/Tier

#### Features

- » AutoLock System with AutoLock Lever adjusts height setting easily and is safe and secure
- » Locking Pins and adjustable moving arms for easy set up and tear down
- » The Adjustable Rubber Foot fine tunes height and levels the KS410B for maximum stability

#### Specifications

Weight: 11.6 kg (25.5 lbs.)

Folded size: 705 mm x 605 mm x 175 mm  
(27.7" x 23.8" x 6.9")

Load Capacity: 130 kg (286 lbs.)

#### Base Z

##### Specifications

Height: 605 mm - 930 mm (23.8" - 36.6")

Width: 510 mm - 850 mm (20" - 33.5")

Support depth: 450 mm (17.7")

#### Upper Tier

##### Specifications

Height: 240 mm - 430 mm (9.4" - 16.9")

Depth: 400 mm (15.7")

Angle: 70°, 90°

Load Capacity: 40 kg (88 lbs.)



Adjustable rubber foot for height fine tuning and stable leveling.



Adjustable Stopper accommodates a variety of keyboard sizes



#### AutoLock System

- » One touch height setting
- » Lift up both arms and the AutoLock sets securely at required height
- » Press the lever to lower or to pack away



#### Locking Pins

- » Located on the keyboard resting arms and the stand legs, locking pins allow quick and secure set up
- » To pack away, press the pins and flip out the arms



TOBIAS SAMMET  
EDGUY/AVANTASIA

## MICROPHONE STANDS

HERCULES Quik-N-EZ microphone stands and booms have innovative designs that are safe, secure, solid and stable.

HERCULES Quik-N-EZ microphone stands offer new and state-of-the-art approaches providing stands that are incredibly versatile and easy to use!

Photo Thorsten Doerr



## MICROPHONE

### MS432B

Quick Turn Tripod Microphone Stand w/2-in-1 Boom

**Feature**

- » Stage Series
- » 2-in-1 Boom Clamp
- » Durable and collapsible tripod legs provide strong support and ease of transportation
- » Quick Turn Clutch

**Specifications**

Height: 875 mm – 1,475 mm (34.4" – 58.1")  
 Weight: 2.2 kg (4.9 lbs.)  
 Base radius: 340 mm (13.4")  
 Boom length: 780 mm (30.7")  
 Folded size: 805 mm x 95 mm x 95 mm  
 (31.7" x 3.7" x 3.7")



### MS434B

Quick Turn Tripod Microphone Stand w/3-in-1 Boom

**Feature**

- » Stage Series
- » 3-in-1 Boom Clamp
- » Quick Turn Clutch
- » Holds any combination of two microphones, devices, or other content creation accessories

**Specifications**

Height: 970 mm - 1,680 mm (38.19" – 66.1")  
 Weight: 2.4 kg (5.3 lbs.)  
 Base Radius: 340 mm (13.4")  
 Boom Length: 780 mm (30.7")  
 Folded Size: 95 mm x 95 mm x 950 mm  
 (3.74" x 3.74" x 37.4")



### MS202B

Quick Turn H-Base Microphone Stand

**Features**

- » Stage Series
- » Quick Turn Clutch
- » HERCULES H-Base

**Specifications**

Height: 920 mm – 1,680 mm (36.2" – 66.1")  
 Weight: 3.4 kg (7.5 lbs.)  
 Base radius: 120 mm (4.7")  
 Folded size: 910 mm x 266 mm x 35 mm  
 (35.8" x 10.5" x 1.4")



#### Quick Turn Clutch

Quick Turn - Simply turn one quarter for quick and easy height adjustment.



#### 2-in-1 Boom Clamp

Easily adjust boom length and angle at the same time.



#### 3-in-1 Boom Clamp

Simultaneously secures boom length, height and angle with a single adjustment knob.



#### H-Base

Weighted for maximum stability.

**MS531B**  
EZ Clutch Tripod  
Microphone Stand

- Features**
- » Microphone Holder, EZ Boom Retainer and EZ Clutch
  - » Durable aluminum die-cast base with tripod legs
  - » The Microphone Holder quickly secures in place and fits all standard size mic stands

**Specifications**  
Height: 1,045 mm - 1,680 mm (41.1" - 66.1")  
Weight: 2.6 kg (5.7 lbs.)  
Boom length: 780 mm (30.7")  
Base radius: 340 mm (13.4")  
Folded size: 885 mm x 95 mm x 95 mm  
(34.8" x 3.7" x 3.7")



**MS532B**  
EZ Clutch Tripod Microphone Stand

- Features**
- » Microphone Holder, 2-in-1 Boom Clamp and EZ Clutch
  - » Durable aluminum die-cast base with tripod legs
  - » The Microphone Holder quickly secures in place and fits all standard size mic stands.

**Specifications**  
Height: 1,045 mm - 1,680 mm (41.1" - 66.1")  
Weight: 2.6 kg (5.7 lbs.)  
Base radius: 340 mm (13.4")  
Boom length: 780 mm (30.7")  
Folded size: 885 mm x 95 mm x 95 mm  
(34.8" x 3.7" x 3.7")

**MS631B PLUS**  
EZ Grip Height Adjustment  
Tripod Microphone Stand

- Features**
- » Microphone Holder, EZ Boom Retainer and EZ Grip Height Adjustment
  - » EZ Grip Height Adjustment with one hand
  - » Durable aluminum die-cast base with tripod legs
  - » The Microphone Holder quickly secures in place and fits all standard size mic stands

**Specifications**  
Height: 1,115 mm - 1,680 mm (43.9" - 66.1")  
Weight: 2.9 kg (6.4 lbs.)  
Boom length: 780 mm (30.7")  
Base radius: 340 mm (13.4")  
Folded size: 925 mm x 90 mm x 90 mm  
(36.4" x 3.5" x 3.5")



**MS632B PLUS**  
EZ Grip Height Adjustment  
Tripod Microphone Stand

- Features**
- » Microphone Holder, 2-in-1 Boom Clamp and EZ Grip Height Adjustment
  - » EZ Grip Height Adjustment with one hand
  - » Durable aluminum die-cast base with tripod leg
  - » The Microphone Holder quickly secures in place and fits all standard size mic stands

**Specifications**  
Height: 1,115 mm - 1,680 mm (43.9" - 66.1")  
Weight: 2.9 kg (6.4 lbs.)  
Base radius: 340 mm (13.4")  
Boom length: 780 mm (30.7")  
Folded size: 925 mm x 90 mm x 90 mm  
(36.4" x 3.5" x 3.5")

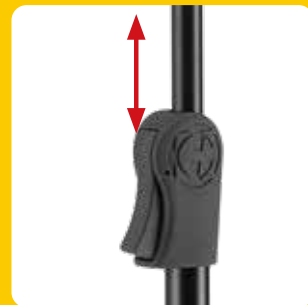

**EZ Clutch**  
Press for a quick height adjustment. EZ Clutch releases to lock for secure and stable positioning.



**Quik-N-EZ Boom Retainer**  
Flip the lever of EZ retainer up or down to mount the boom to the floor stand.



**2-in-1 Boom Clamp**  
Easily adjust boom length and angle at the same time.



**Microphone Holder**  
The Microphone Holder quickly secures in place and fits all standard size mic stands.



**EZ Grip Height Adjustment**  
Adjust with one hand.



**Quik-N-EZ Boom Retainer**  
Flip the lever of EZ retainer up or down to mount the boom to the floor stand.

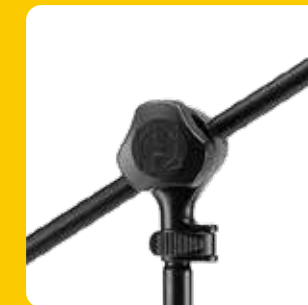

**2-in-1 Boom Clamp**  
Easily adjust boom length and angle at the same time.



**Microphone Holder**  
The Microphone Holder quickly secures in place and fits all standard size mic stands.

**MS533B**

**EZ Clutch Tripod Microphone Stand**

With the Hideaway Boom Stand MS533B can easily be converted to a boom or straight stand.

**Features**

- » EZ Clutch
- » 2-in-1 Boom Clamp
- » Durable aluminum die-cast base with tripod legs
- » The Microphone Holder quickly secures in place and fits all standard size mic stands

**Specifications**

Height: 1,070 mm - 2,400 mm (42.1" - 94.5")  
 Weight: 2.6 kg (5.7 lbs.)  
 Boom length: 780 mm (30.7")  
 Base radius: 340 mm (13.4")  
 Folded size: 980 mm x 95 mm x 95 mm (38" x 3.7" x 3.7")



**MS401B PLUS**

**Transformer Microphone Stand**

**Features**

- » Swivel legs adjust easily and offer versatile positioning
- » EZ Grip height adjustment with one hand
- » Tilting base and swivel leg
- » The Microphone Holder quickly secures in place and fits all standard size mic stands

**Specifications**

Height: 1,030 mm - 1,680 mm (40.6" - 66.1")  
 Weight: 4.2 kg (9.3 lbs.)  
 Base radius: 370 mm (14.6")  
 Folded size: 970 mm x 125 mm x 103 mm  
 (38.2" x 4.9" x 4")



**MS201B PLUS**

**"H" Base Microphone Stand**

**Features**

- » EZ Grip height adjustment with one hand
- » Weighted HERCULES H-Base
- » The Microphone Holder quickly secures in place and fits all standard size mic stands

**Specifications**

Height: 1,010 mm - 1,680 mm (40.2" - 66.1")  
 Weight: 4.3 kg (9.5 lbs.)  
 Base radius: 120 mm (4.7")  
 Folded size: 970 mm x 360 mm x 70 mm  
 (38.2" x 14.2" x 2.8")



**Hideaway Boom**

Converts easily and quickly to either a boom or straight microphone stand.



**EZ Clutch**

Press for a quick height adjustment. EZ Clutch releases to lock for secure and stable positioning.



**Microphone Holder**

The Microphone Holder quickly secures in place and fits all standard size mic stands



**Tilting Base and Swivel Legs**

Smoothly adjusts to any angle (45° to 90° angles are recommended).



**EZ Grip Height Adjustment**

Adjust with one hand.



**H-Base**

Weighted for maximum stability.

**MS120B**

Low Profile "H" Base Mic Stand

**Features**

- » Ideal for drum and amp mics with limited floor space
- » 2-section telescopic boom
- » HERCULES H-Base
- » The Microphone Holder quickly secures in place

**Specifications**

Height: 355 mm (14.0")  
 Weight: 2.9 kg (6.4 lbs.)  
 Boom length: 440 mm - 800 mm (16.9" - 30.3")  
 Base radius: 90 mm (3.9")  
 Folded size: 470 mm x 375 mm x 110 mm  
 (18.5" x 14.8" x 4.3")



**MS540B**

Low Profile Tripod Microphone Stand

**Features**

- » Great for drum and amp microphones
- » 2-section telescopic boom on a durable aluminum die-cast base with tripod legs
- » The Microphone Holder quickly secures in place

**Specifications**

Height: 655 mm (25.8")  
 Weight: 2.1 kg (4.7 lbs.)  
 Boom length: 780 mm - 1,220 mm (30.7" - 48")  
 Base radius: 340 mm (13.4")  
 Folded size: 782 mm x 105 mm x 90 mm  
 (30.8" x 4.1" x 3.5")



**MS100B**

H-Base Microphone Stand

**Features**

- » Quik-N-EZ Height Adjustment Lever
- » HERCULES H-Base
- » The Microphone Holder quickly secures in place

**Specifications**

Height: 280 mm - 445 mm (11" - 17.5")  
 Weight: 1.6 kg (3.5 lbs.)  
 Base radius: 80 mm (3.1")  
 Folded size: 285 mm x 194 mm x 34 mm  
 (11.2" x 7.6" x 1.3")



**MS300B**

Low Profile Straight Microphone Stand

MS300B is perfect for any low profile application e. g. kick drum

**Features**

- » Quik-N-EZ Height Adjustment Lever
- » Tilting base
- » Swivel legs
- » The Microphone Holder quickly secures in place

**Specifications**

Height: 315 mm - 475 mm  
 (12.4" - 18.7")  
 Weight: 1 kg (2.2 lbs.)  
 Base radius: 170 mm (6.7")  
 Folded size: 310 mm x 98 mm x 72 mm  
 (12.2" x 3.9" x 2.8")



**Quik-N-EZ Height Adjustment Lever**

Press for a fast and easy height adjustment



**ACCESSORIES**

**MH100B**

Microphone Holder

The Microphone Holder quickly secures in place and fits all standard size mic stands.

**Features**

Fits all mic stands without top washers

**Specifications**

Accept mic size: 20 mm - 35 mm (0.8" - 1.4") O/D  
 Fit Tubing: 15.9 mm (0.63")



**MH101B**

Microphone Holder

The Microphone Holder quickly secures in place and fits all standard size mic stands.

**Features**

Fits all mic stands without top washers

**Specifications**

Accept mic size: 25 mm - 30 mm (1" - 1.1") O/D  
 Fit Tubing: 15.9 mm (0.63")



**MSB001**

Speaker & Microphone Stand Bag

**Specifications**

Before expansion: 1,240 mm x 180 mm x 150 mm (18.8" x 7.1" x 6")

2-pc HERCULES Mic Stand **OR** 1-pc HERCULES Speaker Stand (SS400B/SS410B)

After Expansion: 1,240 mm x 245 mm x 150 mm (18.8" x 9.6" x 6")

4-pc HERCULES Mic Stand **OR** 2-pc HERCULES Speaker Stand (SS400B/SS410B)

**OR** 1-pc HERCULES Speaker Stand (SS700B/SS710B)

Load Capacity: 20 kg (44 lbs.)



**MH200B**

POP Filter

**Features**

- » Get the best vocal recordings
- » Double layered mesh screen
- » Easy to attach to microphone stands and booms

**Specifications**

Diameter: 155 mm (6.1")  
 Gooseneck Length: 340 mm (13.4")  
 Net Weight: 280 g (0.62 lbs.)



**HA700**

Guitar Strap and Headphone Holder

**Features**

- » Lightweight and handy
- » Suitable for guitar & music stands

**Specifications**

Arm Length: 108 mm (4.2")  
 Weight: 184 g (0.4 lbs.)  
 Load Capacity: 2 kg (4.41 lbs.)







## SPEAKER & LIGHTING STANDS

HERCULES Quik-N-EZ speaker and lighting stands are engineered for easy setups that save time and effort.

HERCULES provides solutions: The Quik-N-EZ Series offers innovative devices that ensure speaker and lighting set up is painless.



### SS200BB

#### Speaker Stand Pack

Includes a pair of stands in a sturdy carrying bag that's ideal for backline and rental companies or touring musicians.

#### Features

- » Smart adaptor for 35/38mm speaker pole sockets
- » Tripod leg housing
- » Safety pin

#### Specifications

Height: 1,280 mm – 2,050 mm (50.4" – 80.7")

Weight: 4.5 kg (9.9 lbs.)

Base Radius: 660 mm (26")

Load Capacity: 45 kg (99.2 lbs.)

Folded Size: 1,130 mm × 150 mm × 150 mm  
(44.5" × 5.9" × 5.9")

\* Measurement of single stand



#### Smart Adaptor

The new Smart Adaptor is designed for easy fitting onto 35/38mm (1.38" / 1.5") speaker pole sockets. Simply shift the cover to convert it from a 35mm to a 38mm fitting.



## SS400B/SS410B

### AutoLock Speaker Stand

The HERCULES Auto Lock Speaker Stand SS400B/SS410B features the Quick-N-EZ Auto Lock System, the built-in metal leg housing, all-aluminum tubes, and a safety pin for security.

#### Features

- » Quik-N-EZ AutoLock
- » Built-In metal leg housing
- » Lightweight all-aluminum tubes
- » Safety pins

#### SS400B

##### Specifications

Height: 1,170 mm - 2,100 mm ( 46.1" - 82.7")  
 Weight: 2.9 kg (6.4 lbs.)  
 Base Radius: 660 mm (26")  
 Load Capacity: 45 kg (99.2 lbs.)  
 Folded Size: 1,163 mm x 150 mm x 125 mm (45.8" x 6" x 5")  
 Compatible with 35mm and 38mm via additional flange.

#### SS410B (Built-in EZ Adaptor)

##### Specifications

Height: 1,170 mm - 2,100 mm ( 46.1" - 82.7")  
 Weight: 3.5 kg (7.7 lbs.)  
 Base Radius: 660 mm (26")  
 Load Capacity: 45 kg (99.2 lbs.)  
 Folded Size: 1,235 mm x 150 mm x 125 mm (48.6" x 6" x 5")  
 \*Built in EZ Adaptor feature expands from 35 mm - 40 mm (1.38" - 1.57").



SS400B

SS410B

## SS700B/SS710B

### Gear Up Speaker Stand

The HERCULES Gear Up Speaker Stand SS700B/SS710B features the Quick-N-EZ Gear Up System to raise and lower speakers to desired height and securely locks them in place.

#### Features

- » Quik-N-EZ Gear Up
- » Built-in metal leg housing
- » Lightweight all-aluminum tubes
- » Reinforced dual-brace leg construction

#### SS700B

##### Specifications

Height: 1,150 mm - 2,180 mm (45.3" - 85.9")  
 Weight: 6.2 kg (13.7 lbs.)  
 Base Radius: 660 mm (26")  
 Load Capacity: 45 kg (99.2 lbs.)  
 Folded Size: 1,254 mm x 228 mm x 204 mm (49.4" x 9" x 8.0")  
 Compatible with 35mm and 38mm via additional flange.

#### SS710B (Built-in EZ Adaptor)

##### Specifications

Height: 1,150 mm - 2,180 mm(45.3" - 85.9")  
 Weight: 6.8kg (15 lbs.)  
 Base Radius: 660 mm (26")  
 Load Capacity: 45 kg (99.2 lbs.)  
 Folded Size: 1,254 mm x 228 mm x 204 mm (49.4" x 9" x 8.0")  
 Built in EZ Adaptor feature expands from 35 mm - 40 mm (1.38" - 1.57")



SS700B

SS710B

WATCH THE VIDEO



## QUIK-N-EZ SERIES

### Quik-N-EZ AutoLock

With the knob on "LOCK", the AutoLock allows you to easily lift the upper tube to the desired height as the design stops the speaker from sliding back down.



Lock Position



Unlock Position

## SS100B

### EZ Adaptor

#### Features

- » Secures the speaker on the stand
- » Fits speaker bottom holes from 35 mm - 40 mm (1.38" - 1.57").

#### Specifications

Height: 170 mm (6.7")  
 Weight: 0.8 kg (1.8 lbs.)  
 Size: 175 mm x 82 mm x 55 mm (7" x 3.2" x 2.2")

WATCH THE VIDEO

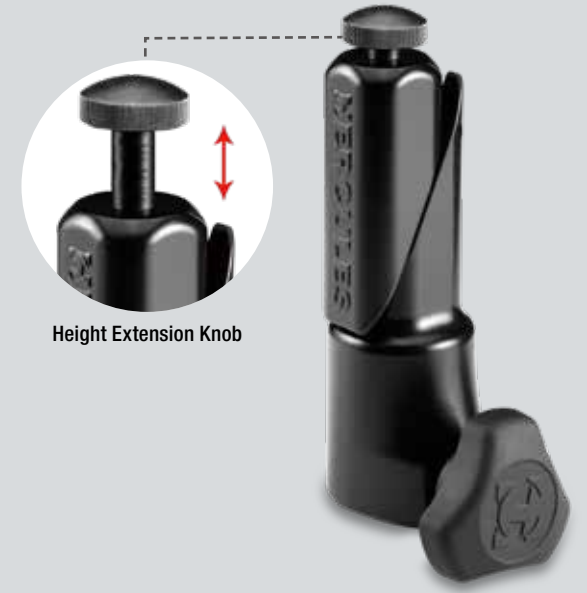

Height Extension Knob

# LS700B

## Gear Up Lighting Stand

The HERCULES Gear Up Lighting Stand LS700B features the Quick-N-EZ Gear Up System, a square T-bar with clip for easy mounting, and dual-braced tripod leg construction.

### Features

- » Quik-N-EZ Gear Up
- » Square steel T-Bar with clip for easy mounting
- » Built-in metal leg housing
- » Lightweight all-aluminum tubes
- » Reinforced dual-brace leg construction

### Specifications

- Height: 1,640 mm – 3,500 mm (64.6"–137.8")
- Weight: 10.4 kg (22.9 lbs.)
- Base Radius: 920 mm (36.2")
- Load Capacity: 45 kg (99.2 lbs.)
- Folded Size: 1,495 mm x 243 mm x 199 mm (58.9" x 9.6" x 7.8")
- T-Bar Length: 1,220 mm (48")
- Accept Flange at 35 mm (1-3/8")



### Quik-N-EZ Gear Up

Drive upper 2 shafts simultaneously and raise a speaker or light to full height quickly and easily.



MS401B



## MULTIMEDIA STANDS

HERCULES provides comprehensive solutions for musicians to integrate technology with their music!

HERCULES multimedia stands are developed to meet all the demands of today's musicians accommodating tablets of all sizes, smartphones, laptops and more. Our stands are compatible with various sized and shaped tubes (round or square tubes) as well as table tops, desks, hi-hat stands and more.

Play music freely and flexibly with HERCULES multimedia stands.

### DG107B

#### DG Adaptive Series Universal Podcast Mic & Camera Arm Stand

(Supports camera, microphone, DG207B, DG307B)

##### Features

- › TightVice™ locking & 360° rotating mechanism:  
specialized locking mechanism holds device safely and tightly right in place
- › Built-in flexible ball joints and axes:  
allows you to adjust the device to any angle that fit you needs
- › Wider support range:  
1/4" - 20 camera screw thread, 3/8" mic thread, 3/8" - 5/8" mic thread adaptor  
(connecting action cameras like GoPro or compact cameras)
- › More mounting options:  
attach on desk, round and square tube for live broadcast, video or photo shooting

##### Specifications

Clamping Range: 15 mm - 33 mm (0.6" - 1.3")

Net Weight: 720 g (1.59 lbs.)

Load Capacity: 1 kg (2.2 lbs.)

Folded Size: 90 mm X 80 mm X 455 mm  
(3.54" X 3.15" X 17.9")

Accessories: Hercules cable wraps included



WATCH THE VIDEO



### ADAPTIVE APPLICATIONS



TightVice™ locking &  
360° rotating mechanism



Wider support range



More mounting options

## DG137B

### Multi Mount

#### Features

- » TightVice™ locking & 360° rotating mechanism: Flexible integrated ball joint allows you to precisely adjust the microphone to your desired position while the specialized clamping mechanism ensures the microphone will remain safely and securely in place.
- » Various Mounting Options: Fits microphones and other devices.
- » Adaptive Applications: 3/8" mic thread 5/8" adapter

#### Specifications

Mounting Options: 3/8" Mic Thread, 5/8" Adapter,  
Clamping range: 15 mm - 33 mm (0.6" - 1.3")  
Net Weight: 380 g (0.84 lbs.)  
Load Capacity: 2 kg (4.4 lbs.)  
Folded Size: 85 mm x 70 mm x 205 mm (3.3" x 2.8" x 8.1")



## DG307B

### DG Adaptive Series 2-IN-1 Tablet & Phone Holder

(Supports 6.1"-13" smartphone or tablet)

#### Features

- » TightVice™ locking & 360° rotating mechanism: specialized locking mechanism holds device safely and tightly right in place. With built-in flexible ball joints and axes, you can adjust the device to any angle that fit you needs
- » More mounting options: attach on desk, round and square tube for live broadcast, video or photo shooting

#### Specifications

Mounting Options:  
1/4"-20 threaded hole  
Adaptive desk/tube clamp  
Clamping Range: 15 mm - 33 mm (0.6" - 1.3")  
Net Weight: 570 g (1.26 lbs)  
Load Capacity: 3 kg (6.6 lbs.)  
Folded Size: 260 mm X 95 mm X 115 mm  
(10.2" X 3.7" X 4.5")



WATCH THE VIDEO



## DG207B

### DG Adaptive Series Smartphone Holder

(Supports 4.7" - 6.9" smartphones)

#### Features

- » TightVice™ locking & 360° rotating mechanism: specialized locking mechanism holds device safely and tightly right in place. With built-in flexible ball joints and axes, you can adjust the device to any angle that fit you needs
- » Adaptive applications: universal tripod and lighting connection for live broadcast, video or photo shooting
- » More mounting options: attach on desk, round and square tube for live broadcast, video or photo shooting

#### Specifications

Mounting Options:  
1/4"-20 threaded hole  
Cold shoe socket  
Adaptive desk/tube clamp  
Clamping Range: 15 mm - 33 mm (0.6" - 1.3")  
Net Weight: 320 g (0.71 lbs.)  
Load Capacity: 1 kg (2.2 lbs.)  
Folded Size:  
210 mm x 95 mm x 80mm (8.3" x 3.7" x 3.1")



WATCH THE VIDEO



## DG400BB

### Laptop Stand

#### Features

- » Adjusts easily for perfect height and angle
- » Extra rear-legs provide solid worry-free support to your laptops up to 10 kg (22 lbs.)
- » One-piece design sets-up and tears down easily
- » Lightweight stand folds flat for easy transport and storage
- » Bag included

#### Specifications

3 Height Settings: 220 mm, 270 mm, 315 mm (8.6", 10.6", 12.4")  
Weight: 1.4 kg (3.08 lbs.)  
Load Capacity: 10 kg (22 lbs.)  
Folded size: 360 mm x 175 mm x 66 mm  
(14.1" x 6.9" x 2.6")

EASY ASSEMBLE VIDEO



THE CORY BAND (UK)

# MUSIC STANDS

HERCULES Quik-N-EZ music stands are designed for easy tool-free adjustment, are lightweight, and secure.

HERCULES Quik-N-EZ music stands offer innovative solutions providing stands that are incredibly versatile and easy to use.



## BS418B PLUS

### Orchestra Stand, Perforated Desk

#### Features

- › Perforated aluminum folding desk has page retainers and side locking pins
- › EZ Grip height adjustment with only one hand
- › The EZ Angle Roller with Special Anti-Slip Rubber holds the desk at the desired angle
- › Three-section mechanism allows for lower position

#### Specifications

Desk: 480 mm x 345 mm (18.9" x 13.6")  
 Height: 610 mm - 1,150 mm (24" - 45.3")  
 Weight: 3.1 kg (6.8 lbs.)  
 Base radius: 345 mm (13.6")  
 Load capacity: 5 kg (11 lbs.)  
 Folded size: 680 mm x 130 mm x 215 mm (26.8" x 5.1" x 8.5")



## BS408B PLUS

### Orchestra Stand, Solid Desk

#### Features

- › Solid Aluminum Folding Desk has page retainers
- › EZ Grip height adjustment with only one hand
- › The EZ Angle Roller with Special Anti-Slip Rubber holds the desk at the desired angle
- › Three-section mechanism allows for lower position

#### Specifications

Desk: 480 mm x 345 mm (18.9" x 13.6")  
 Height: 610 mm - 1,150mm (24" - 45.3")  
 Weight: 3.1 kg (6.8 lbs.)  
 Base radius: 345 mm (13.6")  
 Load capacity: 5 kg (11 lbs.)  
 Folded size: 680 mm x 130 mm x 215 mm (26.8" x 5.1" x 8.5")

## QUIK-N-EZ SERIES



### Quick-release mechanism

Quick-release desk for fast set up.



### EZ Grip Height Adjustment

EZ Grip Height Adjustment with one hand.

## DESK TIPS

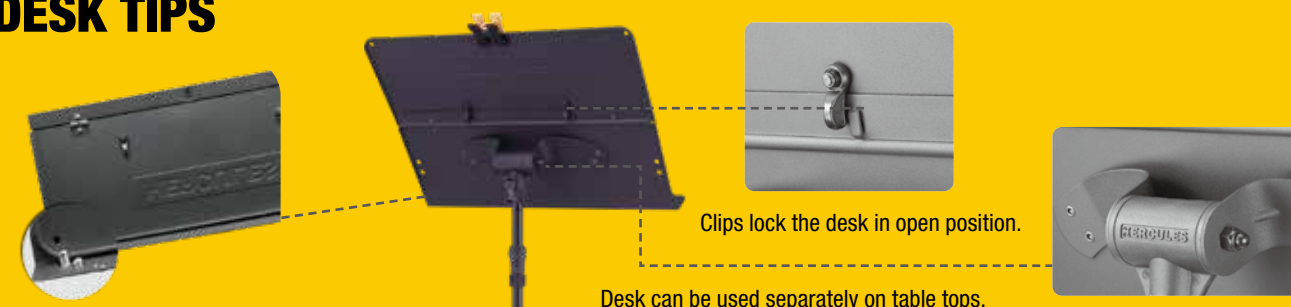

### Folding Desk

Sturdy and light aluminum. Fold the desk in half and secure it with the side locking pin. Press the pin to unfold.

Clips lock the desk in open position. Desk can be used separately on table tops.

### EZ Angle Roller

Simply adjust desk angle.

### BS311B

#### Orchestra Stand, Perforated Desk

**Features**

- » Aluminum perforated folding desk and page retainer
- » EZ Clutch
- » Tilting base which angles 90° - 75° and swivel legs for crowded stages
- » Open taps for instrument pegs

**Specifications**

Desk: 480 mm x 345 mm (18.9" x 13.6")  
 Height: 680 mm - 1,150 mm (26.8" - 45.3")  
 Weight: 3.1 kg (6.8 lbs.)  
 Base radius: 390 mm (15.4")  
 Load capacity: 5 kg (11 lbs.)  
 Folded size: 910 mm x 120 mm x 215 mm (36" x 4.7" x 8.5")



#### Open taps for peg

2 additional instrument peg holes allow the fitting of various pegs to store an instrument on the stand.

\* Peg not included.

### BS301B

#### Orchestra Stand, Solid Desk

**Features**

- » Aluminum perforated folding desk and page retainer
- » EZ Clutch
- » Tilting base which angles 90° - 75° and swivel legs for crowded stages
- » Open taps for instrument pegs

**Specifications**

Desk: 480 mm x 345 mm (18.9" x 13.6")  
 Height: 680 mm - 1,150 mm (26.8" - 45.3")  
 Weight: 3.1 kg (6.8 lbs.)  
 Base radius: 390 mm (15.4")  
 Load capacity: 5 kg (11 lbs.)  
 Folded size: 910 mm x 120 mm x 215 mm (36" x 4.7" x 8.5")



#### Tilting Base and Swivel Legs

The base can be angled 90° to 75° for comfortable positioning.

Swivel legs fit around other equipment, perfect for crowded stages.



Locking Ring - Simply pull up the locking ring to release legs for packing.



EZ Clutch - Press for a quick height adjustment.

### BS200B PLUS

#### Symphony Stand w/ Quick Release Mechanism

**Features**

- » EZ Grip Height Adjustment with one hand
- » Unique sturdy leg design
- » Stackable easily in BSC800 carry cart
- » Quick release mechanism for effortless adjustment

**Specifications**

Height: 690 mm - 1,100 mm (27.2" - 43.3")  
 Weight: 3.1 kg (6.8 lbs.)  
 Base radius: 320 mm (12.6")  
 Load Capacity: 5 kg (11 lbs.)  
 Folded size: 492 mm x 122 mm x 580 mm (19.3" x 4.8" x 22.8")  
 Desk Size: 480 mm x 345 mm (18.9" x 13.6")



Quick release mechanism for effortless adjustment



EZ Grip Height Adjustment with one hand



Stackable Legs



### BSC800

#### Hercules Carry Cart

Music stand cart carries up to 12 pieces of Hercules BS200B PLUS Symphony stands, great for storing in tight spaces, transports stands easily.

**Specifications**

Height: 970 mm (38.2")  
 Weight: 10 kg (22 lbs.)  
 Load Capacity: 45 kg (99.2 lbs.)  
 Base radius: 1,100 mm x 500 mm (43.3" x 19.7")  
 Folded size: 495 mm x 156 mm x 1,044 mm (19.5" x 6.1" x 41.1")



**BS223B**

## Orchestra Stand

**Features**

- » Quick-release desk for fast set up
- » Excellent loading capacity up to 5kg (11 lbs.)
- » EZ grip height adjustment with only one hand
- » Robust solid

**Specifications**

Height: 740 mm - 1190 mm (29.1" - 46.9")

Weight: 3.1kg (6.8 lbs.)

Desk: 480 mm x 345 mm (18.9" x 13.6")

Base Radius: 345 mm (13.6")

Load Capacity: 5 kg (11 lbs.)

Folded size:

350 mm x 160 mm x 770 mm

(13.8" x 6.3" x 30.3")

**BS243B**

## Fourscore Orchestra Stand

**Features**

- » Quick-release desk that measures to hold more sheet music
- » Excellent loading capacity up to 5 kg (11 lbs.)
- » EZ grip height adjustment with only one hand
- » Robust solid

**Specifications**

Height: 710 mm - 1140 mm (28" - 44.9")

Desk: 815 mm x 360 mm (32.1" x 14.2")

Weight: 4.4 kg (9.7 lbs.)

Base Radius: 345 mm (13.6")

Load Capacity: 5 kg (11 lbs.)

Folded size:

822 mm x 165 mm x 361 mm

(32.4" x 6.5" x 14.2")

**BSB001**

## Carrying Bag

BS301B/ BS311B/ BS408B PLUS/ BS418B PLUS

Also fits 2 of the following: DS520B, DS561B, DS538B, DS537B, DS535B, and DS536B.

*\*Please note that the 2 DS535B or DS536B stands should be put into the bag facing opposite directions.*

**Features**

- » Separate compartments for desk and stand to prevent scratching
- » Padded bottom protects the stand

**Specifications**

Size: 850mm x 130 mm x 210 mm (33.5" x 5.1" x 8.3")

Load capacity: 15 kg (33 lbs.)

**HA100**

## Mute Holder

**Features**

- » Designed to hold cornet, trumpet, trombone and French horn mutes
- » Ideal for keeping up to four mutes in a convenient and safe position during performances or practice.
- » Easy to use and adjust

**Specifications**

Weight: 0.5 kg (1.2 lbs.)

Load capacity: 5 kg (11 lbs.)

Folded size: 250 mm x 110 mm x 85 mm  
(9.8" x 4.3" x 3.3")

Ring diameters:

74 mm (2.92") x 1

63 mm (2.48") x 2

47.5 mm (1.87") x 1



Detachable accessory tray included.



**HA103**

## Accessory Tray

**Features**

- » Easy mounting to the music stand
- » Access from both sides
- » Non-slip pad keep your items safe from falling

**DS800B**

## Percussion Table Stand

Designed to safely support dozens of percussion and accessories items for all kinds of performances.

**Features**

- » High density wave foam and rubber edge
- » Foam is removable and replaceable
- » Table height is adjustable and ranges from 560 mm - 920 mm (22" - 36.2")

\*Wave foam is replaceable if required.

**Specifications**

Height: 560 mm - 920 mm (22" - 36.2")

Weight: 4.8 kg (10.6 lbs.)

Base radius: 385 mm (15.2")

Load capacity: 25 kg (55.1 lbs.)

Folded size: 615 mm x 130 mm x 485 mm  
(24.2" x 5.1" x 19")

Table size: 470 mm x 600 mm (18.5" x 23.6")



**Stands you can TRUST!**

**HERCULES**  
STANDS

**BS020BB**

**Compact Music Stand**

**Features**

- » Foldable desk with simple setup and breakdown
- » A specially designed folded lip with page retainers prevents sheets or books from slipping off the desk
- » Easy height adjustment with durable knobs

**Specifications**

Desk: 545 mm x 355 mm (21.5" x 14")  
 Height: 650 mm - 1,080 mm (25.6" - 42.5")  
 Weight: 1.1 kg (2.5 lbs.)  
 Base Radius: 310 mm (12.2")  
 Load Capacity: 2.5 kg (5.51 lbs.)  
 Folded Size: 580 mm x 100 mm x 65 mm  
 (22.8" x 3.9" x 2.6")

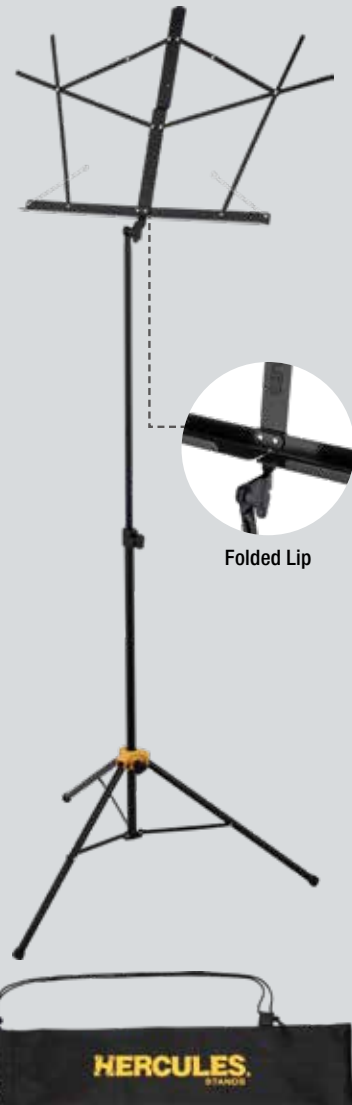

Folded Lip

The storage bag is constructed from environmentally friendly materials. The non-woven fabrics used are recyclable, helping to conserve natural resources.

**BS030BB**

**Foldable Compact Music Stand**

**Features**

- » Compact folding music desk with 2 page retainers on the shelf sides
- » Strong tripod takes sheet music weighed up to 2.5 kg
- » Durable tube holders and knobs offer great stability and easily stretch to desired height

**Specifications**

Height: 600 mm - 1,200 mm (23.62" - 47.3")  
 Weight: 1.1 kg (2.5 lbs.)  
 Base Radius: 300 mm (11.8")  
 Load Capacity: 2.5 kg (5.51 lbs.)  
 Folded Size: 90 mm x 50 mm x 390 mm  
 (3.6" x 2" x 15.4")



**BS050B**

**3-Section Music Stand**

BS050B EZ Desk Music Stand is a lightweight 3-section music stand ideal for use while sitting or standing.

**Features**

- » EZ Desk
- » 3-section mechanism for low, mid and high level positioning
- » Carry bag Included

**Specifications**

Desk: 410 mm x 235 mm (16.1" x 9.3")  
 Height: 530 mm - 1,200 mm (20.8" - 47.2")  
 Weight: 1.28 kg (2.8 lbs.)  
 Base radius: 310 mm (12.2")  
 Load capacity: 2.5 kg (5.5 lbs.)  
 Folded size: 85 mm x 55 mm x 470 mm  
 (3.3" x 2.2" x 18.5")



**BS100B**

**2-Section EZ Glide Music Stand**

BS100B EZ Glide Music Stand is a lightweight stand ideal for use while sitting or standing.

**Features**

- » EZ Desk
- » EZ Angle Gripping Roller
- » EZ Glide

**Specifications**

Desk: 535 mm x 293 mm (21" x 11.5")  
 Height: 690 mm - 1,240 mm (27.1" - 48.8")  
 Weight: 1.45 kg (3.2 lbs.)  
 Base radius: 330 mm (13")  
 Load capacity: 3 kg (6.6 lbs.)  
 Folded size: 110 mm x 85 mm x 675 mm  
 (4.3" x 3.3" x 26.5")

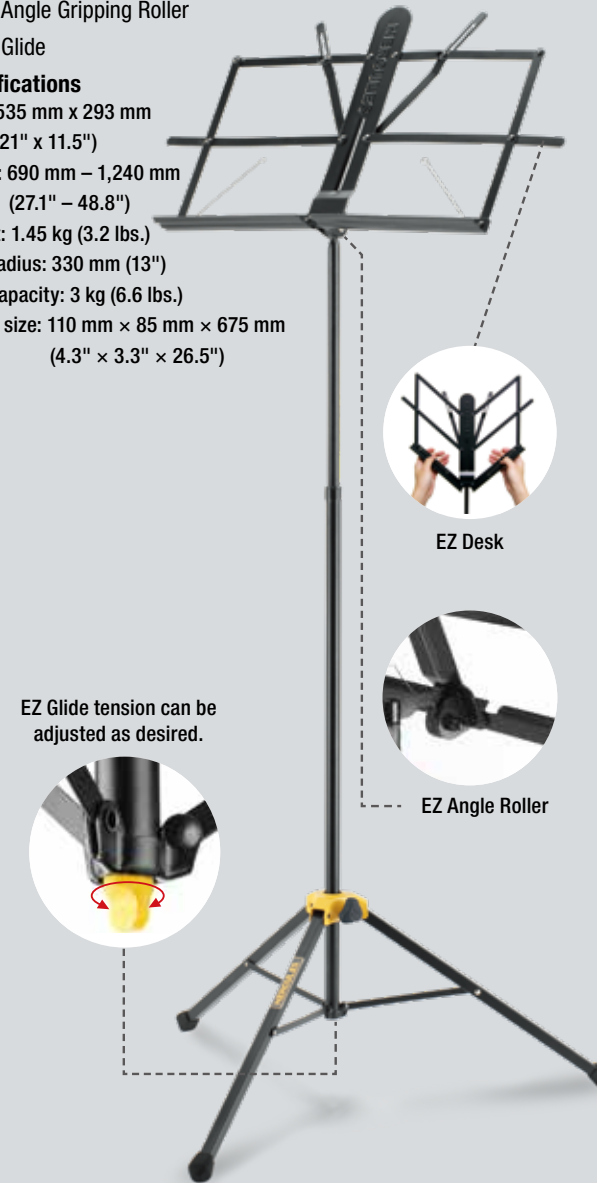

EZ Glide tension can be adjusted as desired.

EZ Desk

EZ Angle Roller

**BSB002**

**Carrying Bag for BS100B**

**Features**

- » Circular zipper for quick access
- » Padded bottom protects the stand

**Specifications**

Size: 110 mm x 660 mm (4.3" x 26")  
 Load capacity: 6 kg (13.2 lbs.)



**BS118BB**

**3-Section EZ Grip Height Adjustment Music Stand w/Bag**

BS118B 3-section EZ Grip Height Adjustment Music Stand w/bag is a 3-section stand ideal for use while sitting or standing.

**Features**

- » Reinforced desk lip
- » EZ desk
- » EZ Angle Roller
- » EZ Grip Height Adjustment with one hand
- » 3-section mechanism allows for low, mid and high positions
- » Carry bag Included

**Specifications**

Desk: 535 mm x 293 mm (21" x 11.5")  
 Height: 550 mm - 1,230 mm (21.7" - 48.4")  
 Weight: 1.67 kg (3.7 lbs.)  
 Base radius: 340 mm (13.4")  
 Load capacity: 2.5 kg (5.5 lbs.)  
 Folded size: 95 mm x 65 mm x 530 mm  
 (3.7" x 2.6" x 20.8")

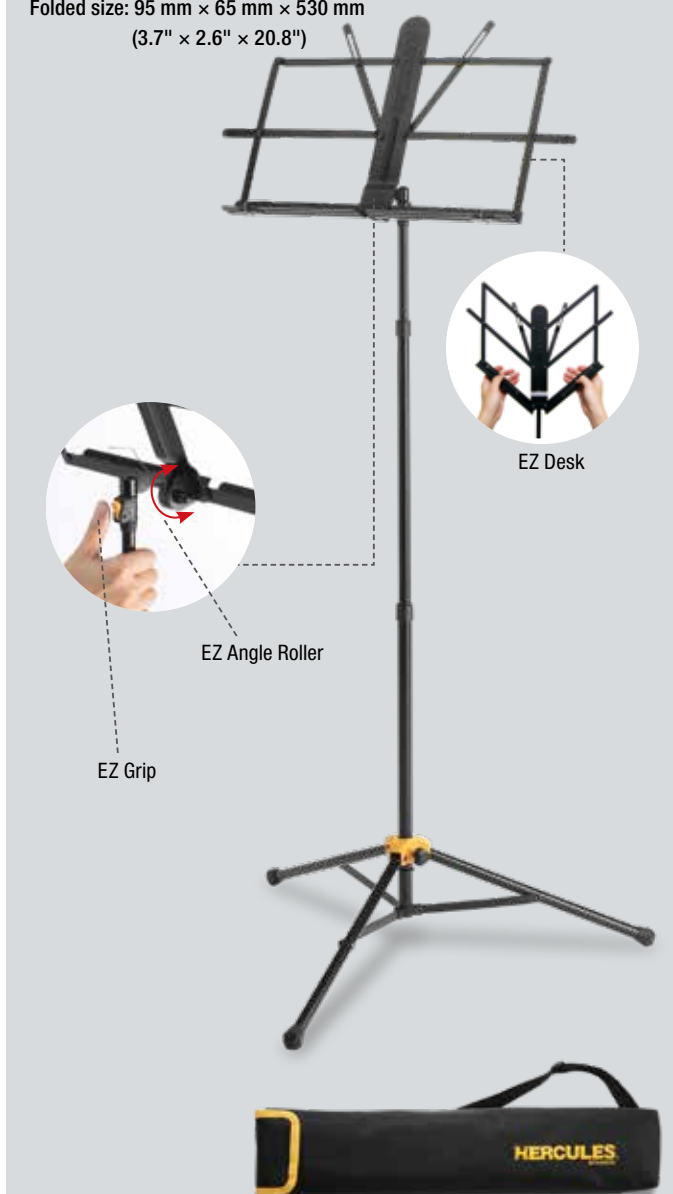

EZ Desk

EZ Angle Roller

EZ Grip



PATRICK SHERIDAN

## WIND & STRINGED INSTRUMENT STANDS

HERCULES EZ-SAFE wind and stringed instrument stands are engineered with innovative safety features that keep all your valuable instruments safe and secure.



### DS630BB

#### AGS Alto/Tenor Saxophone Stand

**Features**

- » Unique AGS (Auto Grip System) design
- » Adjustable backrest
- » Locking pins on leg housing for easy transportation
- » Two extra peg holes on the leg

**Specifications**

Height: 430 mm (16.9")  
 Weight: 0.98 kg (2.2 lbs.)  
 Base Radius: 260 mm (10.2")  
 Load Capacity: 10 kg (22 lbs.)  
 Folded Size: 115 mm x 100 mm x 310 mm  
 (4.5" x 3.9" x 12.2")



### DS730B

#### Tall AGS Alto/Tenor Saxophone Stand

**Features**

- » Unique AGS (Auto Grip System) design
- » Adjustable backrest
- » Fits in GSB001 carry bag

**Specifications**

Height: 925 mm - 1,325 mm (36.4" - 52.2")  
 Weight: 1.93 kg (4.3 lbs.)  
 Base Radius: 355 mm (14")  
 Load Capacity: 10 kg (22 lbs.)  
 Folded Size: 155 mm x 125 mm x 500 mm  
 (6.1" x 4.9" x 19.7")

\* Could fit in GSB001 carrying bag.



## AUTO GRIP SYSTEM

The Auto Grip System (AGS) is driven by the weight of the Saxophone. When placing the bell on the trigger of the yoke, the arms slide down to secure the saxophone. When ready to play, simply lift up the instrument and the AGS releases automatically.



The storage bag is constructed from environmentally friendly materials. The non-woven fabrics used are recyclable, helping to conserve natural resources. On DS510BB, DS531BB, DS543BB, DS550BB, DS640BB, DS630BB, DS513BB, DS530BB, DS532BB, DS533BB, DS571BB, DS562BB.



**DS530BB**  
Alto/Tenor Saxophone Stand

- Features**
- » Folding yoke
  - » Adjustable backrest
  - » Locking pins on leg housing for packing

**Specifications**  
Height: 420 mm (16.5")  
Weight: 0.98 kg (2.2 lbs.)  
Base radius: 260 mm (10.2")  
Load capacity: 10 kg (22 lbs.)  
Folded size: 140 mm x 105 mm x 320 mm  
(5.5" x 4.1" x 12.6")



**DS532BB**  
Alto/Tenor Saxophone,  
Flute/Clarinet Stand

- Features**
- » Folding yoke
  - » Adjustable backrest
  - » Locking pins on leg housing for packing
  - » Velvet flute/clarinet combo peg

**Specifications**  
Height: 420 mm (16.5")  
Weight: 1.05 kg (2.3 lbs.)  
Base Radius: 260 mm (10.2")  
Load Capacity: 10 kg (22 lbs.)  
Folded Size: 140 mm x 105 mm x 320 mm  
(5.5" x 4.1" x 12.6")



**DS533BB**  
Alto/Tenor, Soprano  
Saxophone Stand

- Features**
- » Folding yoke
  - » Adjustable backrest
  - » Locking pins on leg housing for packing
  - » Velvet adjustable soprano saxophone peg

**Specifications**  
Height: 420 mm (16.5")  
Weight: 1.22 kg (2.68 lbs.)  
Base Radius: 260 mm (10.2")  
Load Capacity: 10 kg (22 lbs.)  
Folded Size: 140 mm x 105 mm x 320 mm  
(5.5" x 4.1" x 12.6")

**DS531BB**  
Soprano Saxophone Stand

- Features**
- » Velvet soprano saxophone peg
  - » Swivel legs
  - » Detachable peg for compact storage
- \*Also holds flugelhorns

**Specifications**  
Height: 350 mm (13.8")  
Weight: 0.67 kg (1.41 lbs.)  
Base Radius: 170 mm (6.7")  
Load Capacity: 5 kg (11 lbs.)  
Folded Size: 138 mm x 96 mm x 338 mm  
(5.4" x 3.8" x 13.3")



**DS537B**  
Duo Alto/Tenor Saxophone Stand

- Features**
- » Folding Yokes
  - » Adjustable alto/tenor saxophone backrests
  - » Locking pins on leg housing
  - » One-piece design folds up compactly

**Specifications**  
Height: 395 mm (15.6")  
Weight: 1.77 kg (3.9 lbs.)  
Base Radius: 730 mm x 330 mm (28.7" x 13")  
Load Capacity: 20 kg (44 lbs.)  
Folded Size: 170 mm x 160 mm x 400 mm (6.7" x 6.3" x 15.7")



**DS538B**  
Alto/Tenor, Soprano Saxophone and Flute/Clarinet Stand

- Features**
- » Folding yokes
  - » Adjustable alto/tenor saxophone backrests
  - » Locking Pins on leg housing
  - » One-piece design folds up compactly
  - » Three additional peg holes for the included saxophone and flute/clarinet pegs

**Specifications**  
Height: 395 mm (15.6")  
Weight: 2.13 kg (4.7 lbs.)  
Base Radius: 730 mm x 330 mm  
(28.7" x 13")  
Load Capacity: 20 kg (44 lbs.)  
Folded Size: 170 mm x 160 mm x 400 mm  
(6.7" x 6.3" x 15.7")

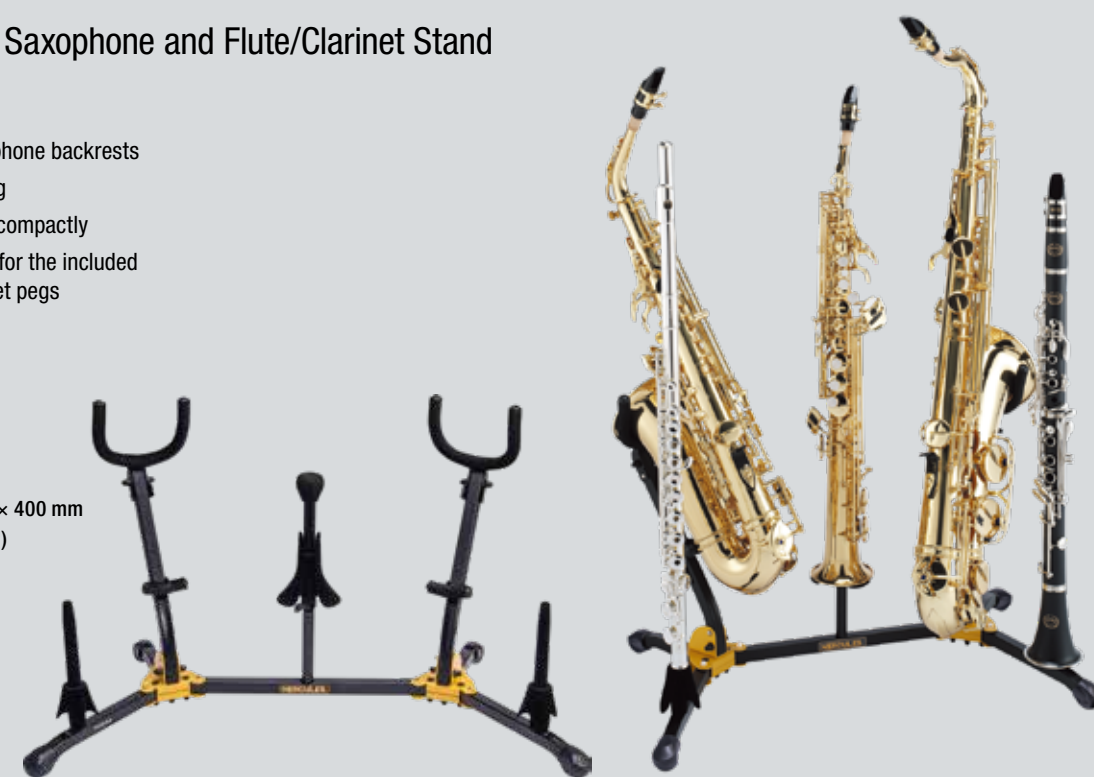

**EZ-SAFE**

**Folding Yoke**

The Folding Yoke sets up and packs down in seconds with a securing pin. Covered with SFF rubber to protect your instrument.



**Adjustable Alto/Tenor Saxophone Backrest**

Flip up the backrest to change positions instantly thus accommodating alto and tenor saxophone, and allowing one-piece packing. Covered with SFF rubber.



### DS535B

#### Baritone Saxophone Stand

**Features**

- » Folding yoke
- » Lever height adjuster
- » Adjustable backrest
- » Swivel legs

**Specifications**

Height: 635 mm – 875 mm (25" - 34.4")  
 Weight: 2.1 kg (4.6 lbs.)  
 Base Radius: 360 mm (14.2")  
 Load Capacity: 20 kg (44 lbs.)  
 Folded Size: 190 mm x 180 mm x 485 mm  
 (7.5" x 7" x 19")



To release EZ pin, slide the pin up and fold the upper post. To fold the legs, simply press the pins.

### DS536B

#### Baritone and Alto/Tenor Saxophone Stand

**Features**

- » Folding yoke
- » Lever height adjustment
- » Adjustable backrest
- » Extra peg for alto or tenor saxophone
- » Swivel legs

**Specifications**

Height: 635 mm – 875 mm (25" – 34.4")  
 Weight: 2.4 kg (5.4 lbs.)  
 Base Radius: 360 mm (14.2")  
 Load Capacity: 20 kg (44 lbs.)  
 Folded Size: 190 mm x 180 mm x 485 mm  
 (7.5" x 7" x 19")

Flip the backrest up to adjust the position; Securely holds different types of baritone saxophones.



### DS640BB

#### Flute/Clarinet Stand

**Features**

- » Velvet telescopic peg
- » Fits flutes and both French and German clarinets
- » Detachable peg for compact packing

**Specifications**

Height: 265 mm (10.4")  
 Weight: 0.5 kg (1.1 lbs.)  
 Base Radius: 135 mm (5.3")  
 Load Capacity: 5 kg (11 lbs.)  
 Folded Size: 99 mm x 79 mm x 214 mm (3.8" x 3.1" x 8.4")



#### Telescopic peg

The tapered peg shape and the self-shortening spring work together to ensure a snug fit and extra stability for long, tall instruments.

### DS543BB

#### Flute, Clarinet and Piccolo Stand

**Features**

- » Two flute/clarinet combo pegs
- » One piccolo peg
- » Swivel legs
- » Detachable pegs for compact packing

**Specifications**

Height: 220 mm (8.7")  
 Weight: 0.7 kg (1.5 lbs.)  
 Base Radius: 170 mm (6.7")  
 Load Capacity: 15 kg (33.1 lbs.)  
 Folded Size: 100 mm x 80 mm x 207 mm (3.9" x 3.1" x 8.1")



## DS562BB

### Alto Flute Stand

#### Features

- » Detachable peg design for easy storage
- » Easy set up
- » Sturdy construction
- » Two additional instrument peg holes

#### Specifications

Height: 345 mm (13.6")  
 Weight: 0.68 kg (1.5 lbs.)  
 Base Radius: 200 mm (7.87")  
 Load Capacity: 5 kg (11 lbs.)  
 Folded Size: 105 mm × 75 mm × 320 mm (3.6" × 3" × 12.5")



## DS561B

### Bass Clarinet/Bassoon stand

#### Features

- » Multi-functional yoke
- » Base rest
- » Lever height adjuster

#### Specifications

Height: 670 mm - 1,010 mm (26.4" - 39.8")  
 Weight: 2.03 kg (4.5 lbs.)  
 Base Radius: 450 mm (17.7")  
 Load Capacity: 15 kg (33.1 lbs.)  
 Folded Size: 162 mm × 160 mm × 643 mm (6.3" × 6.3" × 25.3")



#### Multi-Function Display

The bass clarinet can be placed facing towards or away from the stand for both playing and display purposes. The unique base rest allows the bass clarinet to be held securely even with end pin extended.



### TAPS ON THE STANDS

MODEL NO.	PEGS INCLUDED (QTY)	EXTRA OPEN TAPS	EXTRA OPEN TAPS QTY
DS510BB	1	N	-
DS513BB	3	N	-
DS530BB	0	Y	2
DS531BB	1	N	-
DS532BB	1	Y	1
DS533BB	1	Y	1
DS535B	0	Y	2**
DS536B	1	Y	1
DS537B	0	Y	1
DS538B	3	N	-
DS543BB	3	N	-
DS561B	0	Y	2
DS562BB	1	Y	2
DS640BB	1	N	-

\* All taps can accommodate any add-on pegs including DS501B, DS503B, DS504B, DS602B.

\*\* One only fit alto/tenor saxophone peg.



### PEGS



**DS501B**  
Velvet Peg for Trumpet / Cornet

**Specifications**  
Top diameter:  
25 mm (0.98")



**DS503B**  
Velvet Peg for Soprano Saxophone / Flugelhorn

**Specifications**  
Top diameter:  
40 mm (1.57")

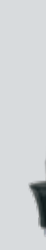

**DS504B**  
Velvet Peg for Piccolo

**Specifications**  
Diameter: 10 mm (0.39")  
Length from base:  
122 mm (4.8")



**DS602B**  
Velvet Peg for Flutes and French/German Clarinets

**Specifications**  
Diameter: 19 mm (0.75")  
Length: 150 mm - 212 mm (5.9" - 8.35")

**DS510BB**

## Trumpet/Cornet Stand

**Features**

- » Velvet peg
- » Solid swivel legs
- » Detachable pegs for compact storage

**Specifications**

Height: 350 mm (13.8")  
 Weight: 0.67 kg (1.47 lbs.)  
 Base Radius: 170 mm (6.7")  
 Load Capacity: 5 kg (11 lbs.)  
 Folded Size: 138 mm x 96 mm x 338 mm  
 (5.4" x 3.8" x 13.3")

**DS531BB**

## Flugelhorn Stand

**Features**

- » Adjustable velvet flugelhorn peg
- » Swivel legs
- » Detachable pegs for compact storage
- » Also holds soprano saxophones

**Specifications**

Height: 350 mm (13.8")  
 Weight: 0.64 kg (1.41 lbs.)  
 Base Radius: 170 mm (6.7")  
 Load Capacity: 5 kg (11 lbs.)  
 Folded Size: 138 mm x 96 mm x 338 mm  
 (5.4" x 3.8" x 13.3")

**DS513BB**

## Trumpet, Cornet and Flugelhorn Stand

**Features**

- » Pegs for trumpets/cornets
- » One peg for flugelhorn
- » Swivel legs
- » Detachable pegs for compact storage

**Specifications**

Height: 350 mm (13.8")  
 Weight: 1.18 kg (2.6 lbs.)  
 Base Radius: 260 mm (10.2")  
 Load Capacity: 15 kg (33.1 lbs.)  
 Folded Size: 138 mm x 96 mm x 338 mm (5.4" x 3.8" x 13.3")

**DS520B**

## Trombone Stand

**Features**

- » Velvet coated EZ Top Bracket
- » Securely holds slide braces adjustable
- » Fits in GSB001 carrying bag

**Specifications**

Height: 860 mm (33.8")  
 Weight: 1.6 kg (3.5 lbs.)  
 Base Radius: 300 mm (11.8")  
 Load Capacity: 5 kg (11 lbs.)  
 Folded Size: 135 mm x 115 mm x 790 mm  
 (5.3" x 4.5" x 31.1")

**EZ Top Bracket**

Two beveled slots secure the slide braces. Adjust the width by twisting the center hand knob.

**DS550BB**

## French Horn Stand

**Features**

- » Yokes and backrest coated with Specially Formulated Foam Rubber
- » 3 locking pins on the leg housing
- » One-piece design folds up compactly

**Specifications**

Height: 320 mm (12.6")  
 Weight: 0.9 kg (2.1 lbs.)  
 Base Radius: 220 mm (8.7")  
 Load Capacity: 10 kg (22 lbs.)  
 Folded Size: 100 mm x 82 mm x 285 mm  
 (4" x 3.2" x 11.2")  
 Yoke Length: 60 mm (2.4")



**DS551B**

## Sousaphone Stand

**Features**

- » Yokes and backrest coated with Specially Formulated Foam Rubber
- » Heavy-duty structure
- » Tripod legs for stability
- » Locking pins
- » Fast and secure setup
- » One-piece design folds up compactly

**Specifications**

Height: 1,110 mm (43.7")  
 Weight: 4.7 kg (10.3 lbs.)  
 Base Radius: 390 mm (15.4")  
 Load Capacity: 30 kg (66.1 lbs.)  
 Folded Size: 850 mm × 260 mm × 233 mm  
 (33.4" × 10.2" × 9.1")

**DS552B**

## Tuba/Euphonium Baritone Horn/Alto Horn Stand

**Features**

- » Heavy-duty stand supports low brass instruments
- » Strong all-in-one compact design
- » Extended supports accommodate different sized instruments

**Specifications**

Height: 915 mm - 1,075 mm (36" - 42.3")  
 Weight: 4.75 kg (10.5 lbs.)  
 Base Radius: 420 mm (16.5")  
 Load Capacity: 30 kg (66.1 lbs.)  
 Folded Size: 275 mm x 175 mm x 535 mm  
 (10.8" x 6.9" x 21.1")

**DS553B**

## Tuba Performer Stand

The DS553B was specially designed for student and professional musicians alike to safely support the tuba whether practicing or performing.

**Features**

- » Adjustable 3-position support
- » Strong, low-profile legs

**Specifications**

Height: 400 mm - 610 mm (15.7" - 24.0")  
 Weight: 2.05 kg (4.5 lbs.)  
 Load Capacity: 25 kg (55.1 lbs.)  
 Base Radius: 235 mm (9.25")  
 Folded Size: 106 mm × 101 mm × 585 mm (4.2" × 4" × 23")

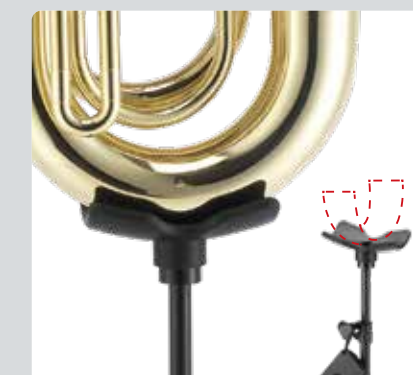

**FOR STUDENTS**  
 Makes practice enjoyable by helping with positioning, breathing and posture

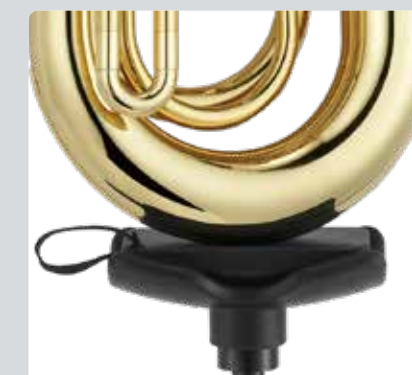

**FOR PROFESSIONAL MUSICIANS**  
 Provides full flexible support and reduces neck and shoulder tension



The TravLite™ Series is designed for touring musicians who need light, portable and solid stands that can securely hold their valuable instrument. HERCULES TravLite stands store easily in the case, and hold the instrument securely.

**DS431B**  
Alto Saxophone In-Bell Stand

**Specifications**  
Height: 350 mm (13.8")  
Weight: 0.38 kg (0.8 lbs.)  
Base Radius: 220 mm (8.7")  
Load Capacity: 15 kg (33.1 lbs.)  
Folded Size: 75 mm x 70 mm x 265 mm (3" x 2.8" x 10.4")



**DS432B**  
Tenor Saxophone In-Bell Stand

**Specifications**  
Height: 440 mm (17.3")  
Weight: 0.4 kg (0.9 lbs.)  
Base Radius: 260 mm (10.2")  
Load Capacity: 15 kg (33.1 lbs.)  
Folded Size: 75 mm x 70 mm x 345 mm (3" x 2.8" x 13.6")



Stand folds quickly and smoothly slips into the bell. A velvet bag is included for protection and easier inside the bell access.

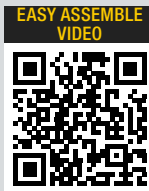

**DS440B**  
Clarinet In-Bell Stand

**Features**  
» Solid construction  
» Sturdy, lightweight and folds up compactly  
» Velvet pads protect the bell

**Specifications**  
Height: 170 mm (6.7")  
Weight: 0.1 kg (0.2 lbs.)  
Base Radius: 115 mm (4.5")  
Load Capacity: 3 kg (6.6 lbs.)  
Folded Size: 60 mm x 60 mm x 115 mm (2.4" x 2.4" x 4.5")



Stores securely inside the bell for easy transport

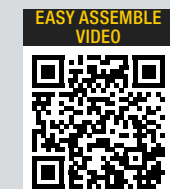

**DS460B**  
Flute In-Footjoint Stand

**Features**  
» Sets up easily  
» Solid, secure, folds and fits inside the footjoint

**Specifications**  
Height: 148 mm (5.8")  
Weight: 0.1 kg (0.2 lbs.)  
Base Radius: 165 mm (6.5")  
Load Capacity: 2.5 kg (5.5 lbs.)  
Folded Size: 40 mm x 40 mm x 173 mm (1.6" x 1.6" x 6.8")



Stand tucks away inside footjoint for the ultimate in compact storage

**DS461B**  
Low B Flute In-Footjoint Stand

**Features**  
» Sets up easily  
» Solid, secure, folds and fits inside the footjoint

**Specifications**  
Height: 175 mm (6.9")  
Weight: 0.1kg (0.2 lbs.)  
Base Radius: 165 mm (6.5")  
Load Capacity: 2.5 kg (5.5 lbs.)  
Folded Size: 40 mm x 40 mm x 173 mm (1.6" x 1.6" x 6.8")



Stand tucks away inside footjoint for the ultimate in compact storage

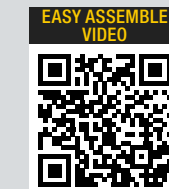

**DS410B**  
Trumpet In-Bell Stand

- Features**
- » Sturdy lightweight construction
  - » Secure and safe storage
  - » Folded, DS410B stores easily in velvet bag inside bell

**Specifications**  
 Height: 175 mm (6.9")  
 Weight: 0.28 kg (0.62 lbs.)  
 Base Radius: 170 mm (6.7")  
 Load Capacity: 5 kg (11 lbs.)  
 Folded Size: 75 mm x 75 mm x 180 mm  
 (3.0" x 3.0" x 7.1")

EASY ASSEMBLE VIDEO



Slip into bell. A velvet bag is included for better protection and easier access inside the bell.

**DS420B**  
Trombone In-Bell Stand

- Features**
- » Sturdy lightweight construction
  - » Secure and safe storage
  - » Folded, DS420B stores easily in velvet bag inside bell of instrument

**Specifications**  
 Height: 870 mm (34.2")  
 Weight: 1.23 kg (2.71 lbs.)  
 Base Radius: 280 mm (11")  
 Load Capacity: 5 kg (11 lbs.)  
 Folded Size: 126 mm x 121 mm x 547 mm  
 (5" x 4.8" x 21.5")

EASY ASSEMBLE VIDEO



**Telescopic Tube**  
 Height extender allows easy access during use and compact packing and storage



Stores perfectly inside the bell  
 Velvet bag is included

**DS580B**  
Cello Stand

- Features**
- » AGS yoke
  - » Special Formulated Foam Rubber covered legs
  - » Extender accommodates increased stand height
  - » Instrument can be stored with end-pin in playing position
  - » Bow hook
  - » Instant Height Adjustment Clutch with locking pin adjusts stand height quickly, easily and securely

**Specifications**  
 Height: 920 mm - 1,200 mm (36.2" - 49.6")  
 Weight: 2.18 kg (4.8 lbs.)  
 Base Radius: 450 mm (17.7")  
 Load Capacity: 15 kg (33 lbs.)  
 Folded Size: 182 mm x 125 mm x 712 mm  
 (7.2" x 5" x 28")  
 Fits ¼, ⅓, ½, ¾, ⅞ and full size cellos

\* Could fit in GSB001 carrying bag.



**Auto Grip System (AGS)**

Cradle the cello peg box on the AGS. The weight of the cello lifts the front levers, securing the instrument on to the stand. Lift the instrument to release.

**DS590B**  
Double Bass Stand

- Features**
- » Sturdy steel construction
  - » 2 locking pins for secure and easy set up
  - » Bow hook
  - » One-piece folding design

**Specifications**  
 Height: 900 mm (35.4")  
 Weight: 3.47 kg (7.63 lbs.)  
 Base Radius: 530 mm x 630 mm (20.9" x 24.8")  
 Load Capacity: 50 kg (110 lbs.)  
 Folded Size: 700 mm x 110 mm x 920 mm  
 (27.5" x 4.3" x 36.2")  
 Fits ¾ and full size double bass



## DS571BB

### Violin/Viola Stand

#### Features

- » Sturdy, lightweight aluminum stand with bow hook
- » Innovative Auto Grip System (AGS)
- » Folds compactly for easy carrying
- » Three-section design
- » Bow hook

#### Specifications

Height: 420 mm - 670 mm (16.5" - 26.4")

Weight: 0.59 kg (1.3 lbs.)

Base Radius: 250 mm (9.8")

Load Capacity: 5 kg (11 lbs.)

Folded Size: 99 mm x 84 mm x 475 mm  
(3.9" x 3.3" x 18.7")

Fits ¼, ⅓, ½, ¾, 7/8 and full size violins and 12-17" violas

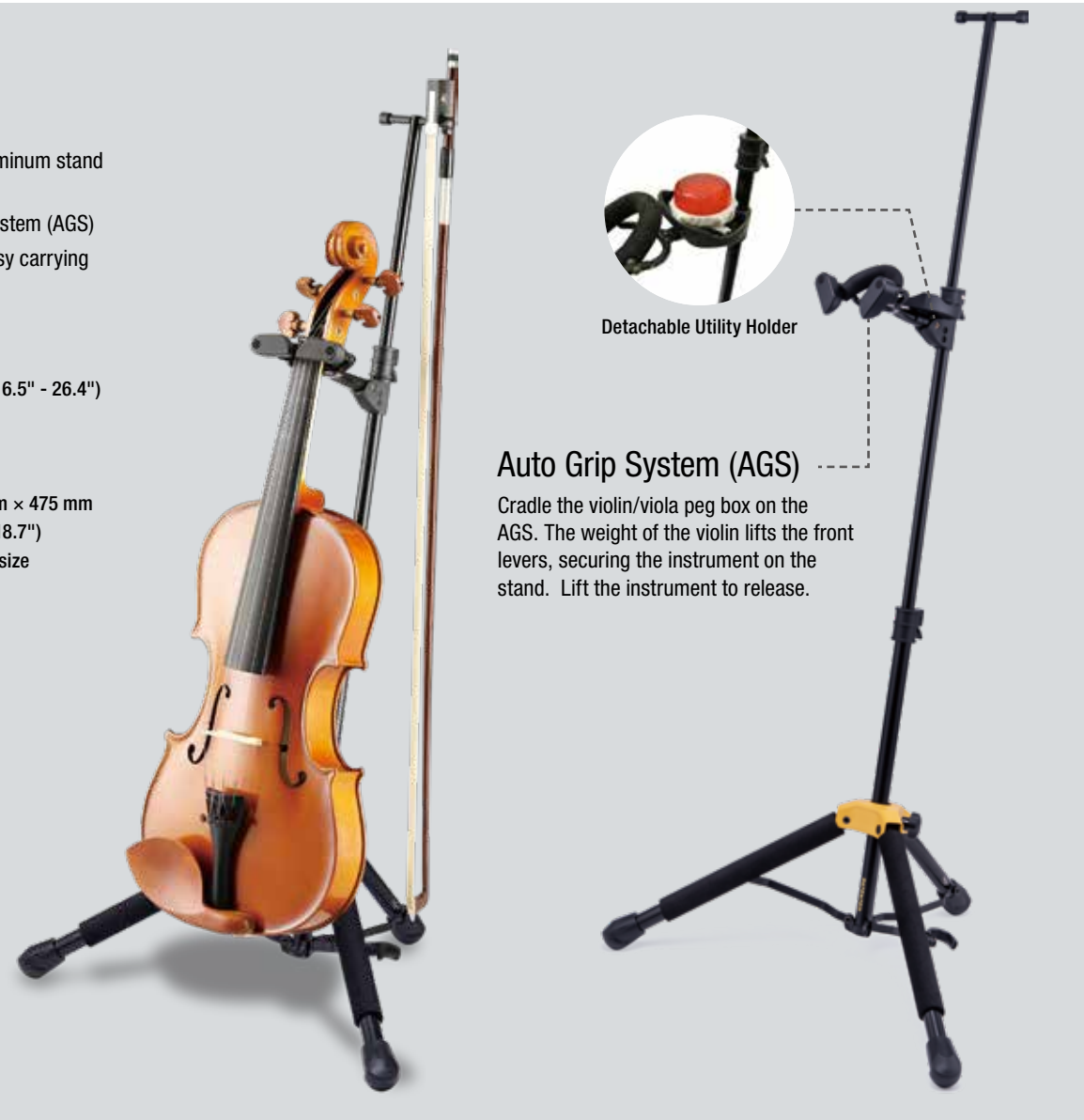

#### Auto Grip System (AGS)

Cradle the violin/viola peg box on the AGS. The weight of the violin lifts the front levers, securing the instrument on the stand. Lift the instrument to release.

## VIOLIN/VIOLA WALL DISPLAYS

AGS Violin/Viola Hangers safely and securely store small stringed instruments

#### Features

- » For store and home use
- » Fits mandolin, ukulele and most 5-string banjos

#### Specifications

Load Capacity: 5 kg (11 lbs.)

Fits: ¼, ⅓, ½, ¾, 7/8 and full size Violins and 12"-17" Violas

### DSP57WB Wood Base Wall Mount



### DSP57SB Slatwall Mount



CASSANDRA SOTOS  
SUNSET RISING / INDEPENDENT



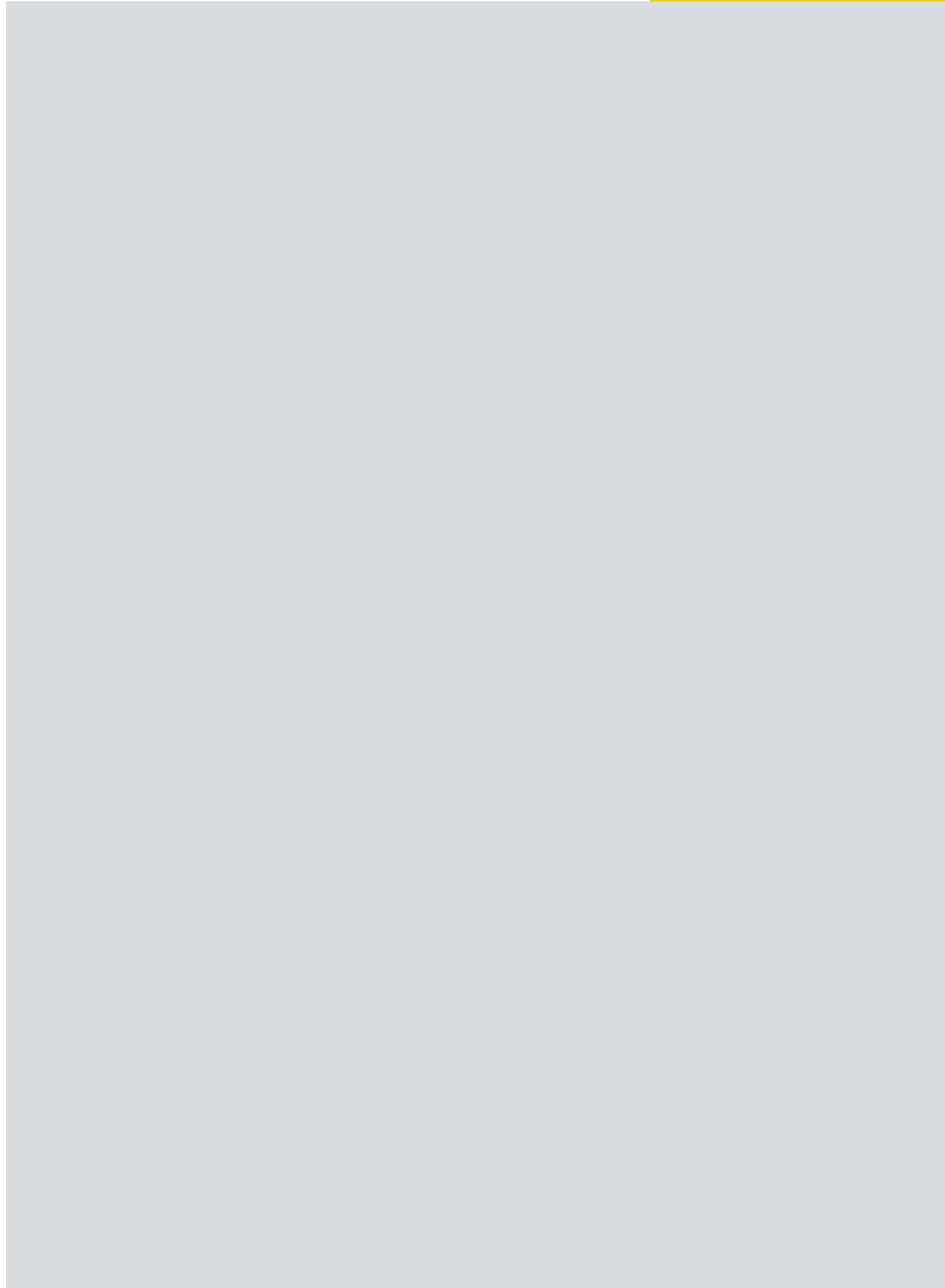
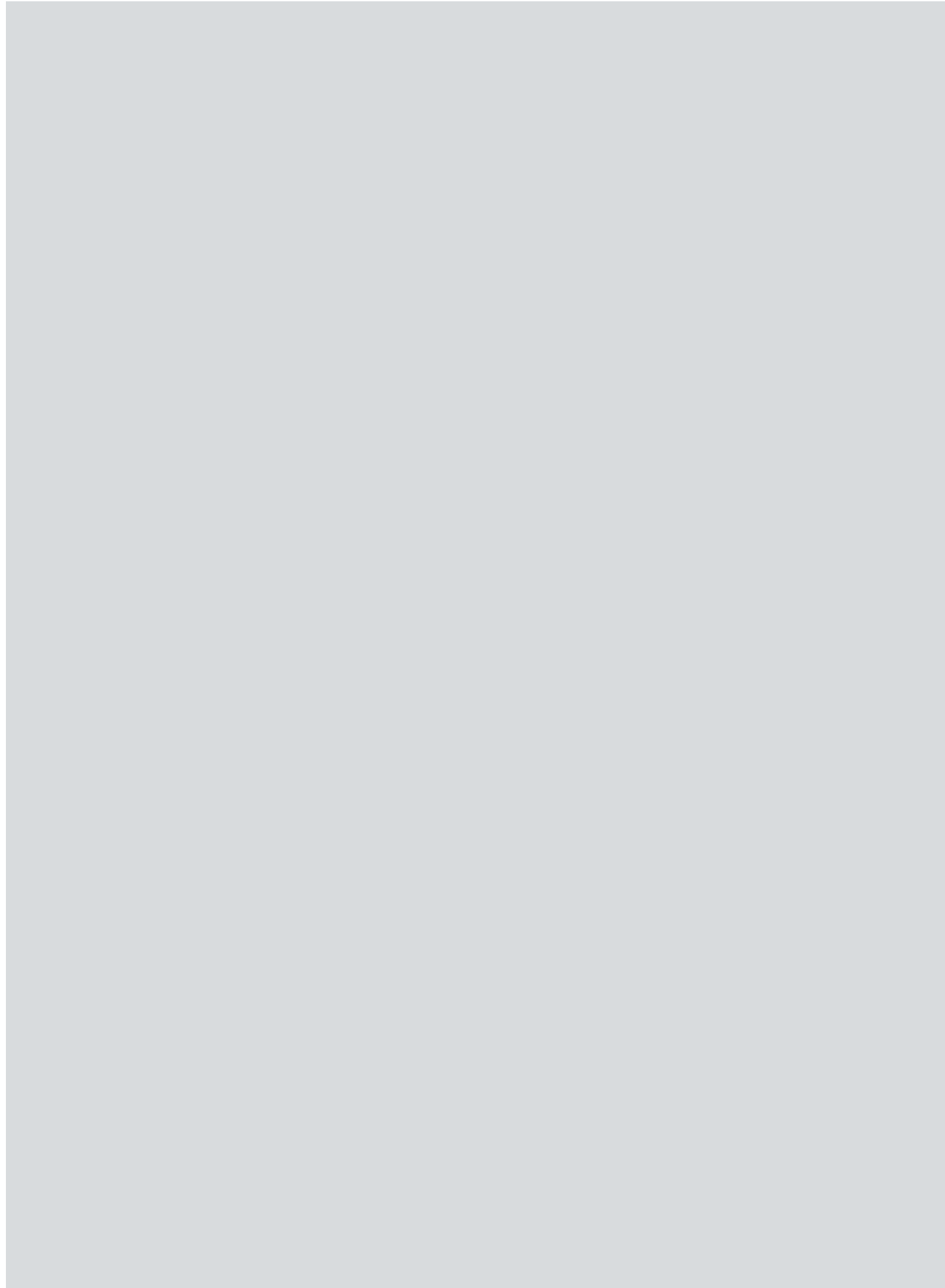



Specifications subject to change without notice.  
© 2023 - 2024 HERCULES

